

RESEARCH IN OPHTHALMIC SCIENCES
Aravind Medical Research Foundation

Annual Report

2021-2022

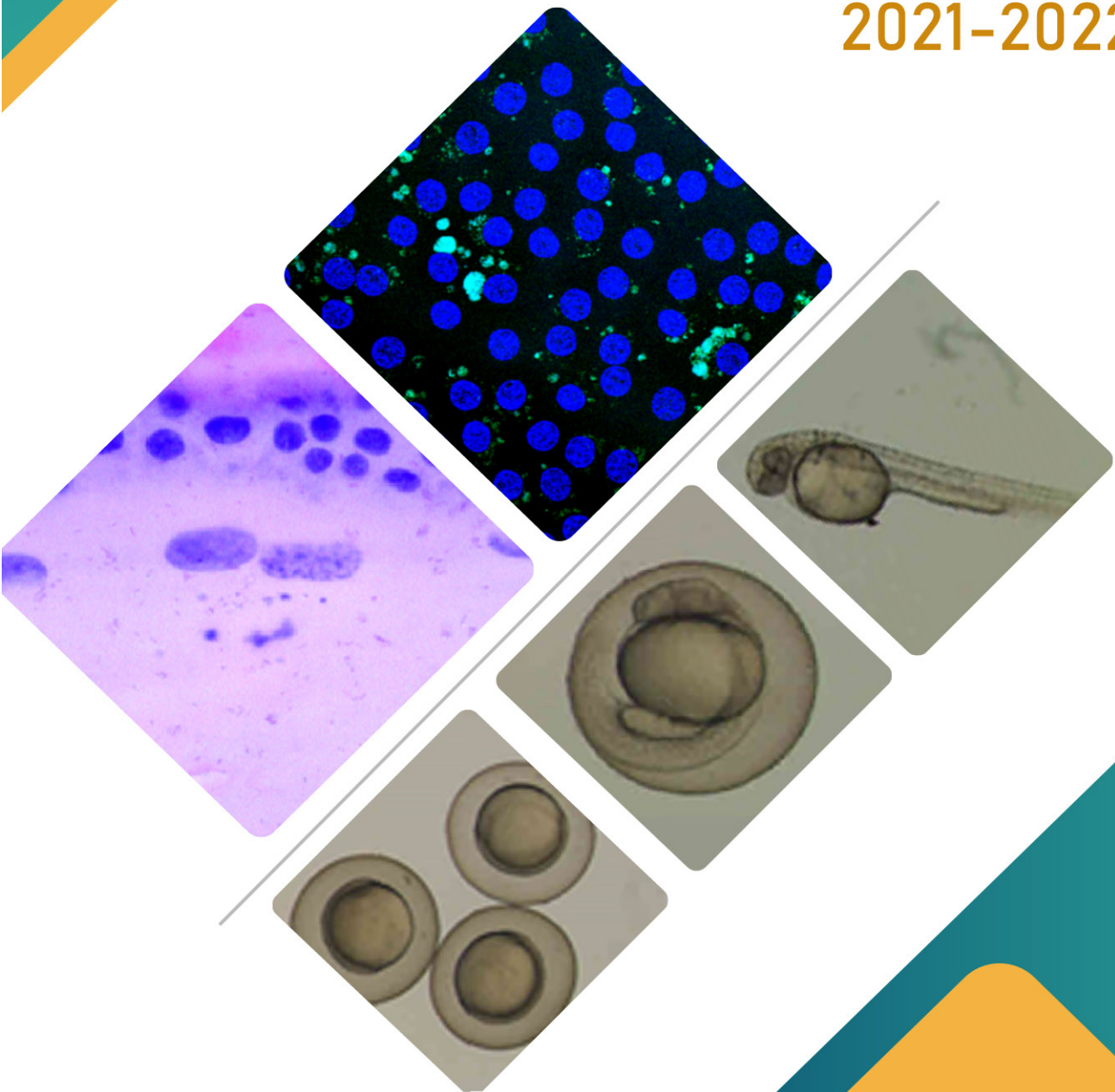

ARAVIND MEDICAL RESEARCH FOUNDATION

Aravind Medical Research Foundation is recognised as Scientific and Industrial Research Organization (SIRO) by the Department of Scientific and Industrial Research (DSIR), Government of India

MISSION

To eliminate needless blindness by providing evidence through research and evolving methods to translate existing evidence and knowledge into effective action.

RESEARCH IN OPHTHALMIC SCIENCES

Dr. G. Venkataswamy Eye Research Institute

Annual Report 2021 - 2022

ARAVIND MEDICAL RESEARCH FOUNDATION

BOARD OF MANAGEMENT



DR. P. NAMPERUMALSAMY,
MS, FAMS



DR. G. NATCHIAR, MS, DO



MR. R.D. THULASIRAJ, MBA



DR. S.R. KRISHNADAS,
DO., DNB



DR. R. KIM, DO., DNB



DR. N. VENKATESH PRAJNA
DO., DNB., FRCophth



DR. S. ARAVIND, MS, MBA



DR. S.R. RATHINAM,
MNAMS, PH.D
HONORARY MEMBER

FACULTY



PROF. K. DHARMALINGAM
Director - Research



PROF. V.R. MUTHUKARUPPAN
Advisor-Research



DR. P. SUNDARESAN
Senior Scientist
Molecular Genetics



DR. C. GOWRI PRIYA
Scientist, Immunology &
Stem Cell Biology



DR. S. SENTHILKUMARI
Scientist, Ocular Pharmacology



DR. A. VANNIARAJAN
Scientist, Molecular Genetics



DR. J. JEYA MAHESHWARI
Scientist, Proteomics



DR. D. BHARANIDHARAN
Scientist, Bioinformatics



DR. O.G. RAMPRASAD
Scientist, Proteomics



DR. DAIPAYAN BANERJEE
Scientist - I, Proteomics



DR. SWAGATA GHOSH
Ramalingaswami
Fellow



DR. ANWAR AZAD P.
Ramalingaswami
Fellow

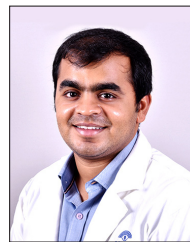

DR. SIDDHARTH
NARENDRAN
Associate Faculty

ARAVIND MEDICAL RESEARCH FOUNDATION

CLINICIAN-SCIENTISTS



DR. P. VIJAYALAKSHMI, MS
Professor of Paediatric
Ophthalmology



DR. S.R. KRISHNADAS,
DO., DNB
Professor of Ophthalmology



DR. SR. RATHINAM,
MNAMS, PH.D
Professor of Ophthalmology &
HOD - Uvea Services



DR. HARIPRIYA ARAVIND, MS
HOD - IOL & Cataract Services



DR. R. KIM, DO., DNB
Professor of Ophthalmology &
Chief Medical Officer



DR. N. VENKATESH PRAJNA
DO., DNB., FRCophth
Professor of Ophthalmology
& HOD - Cornea Services



DR. USHA KIM, DO, DNB
Professor of Ophthalmology
& HOD - Orbit, Oculoplasty &
Ocular Oncology Services



DR. LALITHA PRAJNA,
MD., DNB
HOD - Microbiology



DR. R. SHANTHI, MD
Pathologist



DR. R. SHARMILA, DNB
Medical Consultant
Glaucoma Services



DR. MADHU SHEKAR, DNB
Chief - Cataract Services



DR. MAHESH KUMAR, DO, DNB
Chief - Neuro-ophthalmology
Services

RESEARCH COUNCIL MEMBERS



DR. P. NAMPERUMALSAMY
Chairman



DR. P. VENKATACHALAM
Member



PROF. V.R. MUTHUKKARUPPAN
Member



DR. G. KUMARESAN
Member



DR. S. THIYAGARAJAN
Member



PROF. S. KARUTHAPANDIAN
Member



DR. N. VENKATESH PRAJNA
Member



DR. R. KIM
Member



PROF. K. DHARMALINGAM
Member Secretary

INSTITUTIONAL ETHICS COMMITTEE (IEC)

Chairman

PROF. R. VENKATARATNAM M.A., PH.D
Senior Prof. of Sociology (Retired)
Madurai Kamaraj University, Madurai

Member-Secretary

DR. R. SHARMILA, DNB
Medical Officer, Glaucoma Clinic,
Aravind Eye Hospital, Madurai

Members

DR. C. SRINIVASAN M.SC., PH.D
UGC Emeritus Professor
New No. 2/249 (Old No 2/172), 7th Street, Kalvinagar,
Rajambadi, Madurai - 625021

DR. T.S. CHANDRASEKARAN MS, DO
Ophthalmologist,
No.6, N.M.R.Subbaraman Road, Chokkikulam North,
Madurai

MR. M. SENTHILKUMAR M.A., B.L
Advocate
Plot No.32, Sindanayalar Nagar
Senthamil Nagar, Karuppayoorani East, Madurai

MR. R. RAJA GOVINDASAMY M.A., M.A (USA)
Former Principal, Thiagarajar College
169-1, 2nd Cross Street, I Main Road, Gomathipuram,
Madurai - 625020

DR. S. SABHESAN DPM, MNAMS, PH.D
Consultant – Psychiatrist, Apollo Specialty Hospitals
Lake view Road, K.K.Nagar, Madurai

DR. A. AMIRTHA MEKHALA BDS, MPH, MFDSRCPS
Private Practice - Dental Services
208 Karpaga Nagar 8th Street, K.Pudur, Madurai - 625007

MRS. PREMALATHA PANNEERSELVAM M.A., M.ED
Secretary, Mahatma Montessori Matriculation Hr.Sec.
School, Madurai

DR. J.R. VIJAYALAKSHMI MD (PHARMACOLOGY)
Professor of Pharmacology
CSI college of Dental Sciences, Madurai

MR. ARM. GANESH B.COM., LLB
Advocate, D-3/4, First Cross Street
K.K.Nagar west, Madurai - 625020

DR. LALITHA PRAJNA DNB
Chief - Microbiology, Aravind Eye Hospital, Madurai

FOREWORD



Studies spanning a few years on the identification and validation of serum biomarkers for diabetic retinopathy reached a stage where we can plan to use these predictive biomarkers in clinical settings. The discovery phase studies involving high resolution mass spectrometry and other proteomic technologies led to the identification of additional biomarkers, not reported earlier, which are predictive of onset of retinal complications among diabetes patients. A collaborative project has led to the validation of two of the markers, identified from AMRF, to be specific for the Indian population. This data will appear soon in a reputed journal.

In the area of biomarkers, AMRF continues to explore the usefulness of micro RNAs (MiRNAs) as regulators of diseases such as diabetic retinopathy, ocular surface diseases including fungal and bacterial keratitis. In a parallel study, the role of MiRNAs in ocular stem cells is also being explored. Since MiRNAs are not only involved in disease pathogenesis, AMRF is examining the role of MiRNAs as biomarkers in these studies.

Preliminary studies on the nanocarriers exploring the possibility of using extracellular vesicles in ocular diseases reached a stage where AMRF will attempt the development of novel diagnostics and reconfigurable therapeutics for some of the ocular conditions. AMRF specifically targets diabetic retinopathy, age-related macular degeneration, (AMD), corneal opacity (fungal keratitis), and glaucoma, all included in the WHO priority eye diseases. This project attempts comprehensive characterisation as well as identification of their application potential in ophthalmology.

With all these developments, I hope to see more contributions soon on these fronts and other ongoing research programmes. As in the previous years, AMRF and the Aravind Eye Care System will continue to support and nurture research to achieve the goal of our founder, Dr. G. Venkataswamy.

- *Dr. P. Namperumalsamy*
President, AMRF

INTRODUCTION



COVID pandemic created a challenging time for all activities and severely affected research programmes in India. Reallocation of research funds in the field of biology had its impact on many of our research projects. A major crisis was the non-availability of samples. Despite these, AMRF continued to pursue its research and significant progress was made, thanks to the tireless efforts of scientists and clinicians.

One of the major reasons that helped AMRF continue its routine activities despite the restrictions caused by the pandemic was the excellent measures taken by Aravind Eye Care System. The scholars also attended regular lab work and took care of emergency situations in maintaining the cultures, samples, and chemicals. The dedication of the technical staff in keeping the equipment and the lab running

during these times needs special mention.

Details of progress given in this report show the efforts of our entire team. We hope to return to our normal pace in research this year.

Prof. K. Dharmalingam
Director - Research

CONTENTS

Molecular Genetics	1
Stem Cell Biology	16
Proteomics	23
Ocular Pharmacology	37
Bioinformatics	43
Ocular Microbiology	46
Conferences / Meetings	51
Publications 2021 - 2022	55
Ongoing Research Projects	57

MOLECULAR GENETICS

Ocular genetics is becoming essential for understanding the genomic underpinnings of eye diseases and for the development of novel genotype-specific treatments. The department of Molecular Genetics uses Sanger and next-generation sequencing (NGS) technologies as valuable tools for identifying the genetic causes of numerous inheritable ocular disorders. At present, our lab is focusing on inherited retinal dystrophies such as Leber's congenital amaurosis (LCA), Leber's hereditary optic neuropathy (LHON) and Juvenile X-linked retinoschisis (JXLR) as well as the paediatric ocular cancer, retinoblastoma (RB). Despite the fact that they have an incurable genetic condition, they can be effectively managed with genetically informed therapies to improve their long-term visual outcomes.

Translational Genomics of Paediatric Eye Diseases

- Investigators : Dr.P.Sundaresan,
Dr.A. Vanniarajan
Dr. D. Bharanidharan
Dr. VR. Muthukkaruppan
Dr. P. Vijayalakshmi, Dr. R. Kim
Dr. Usha Kim
- Project Fellows : Gowri Poigaiwar, C. Prakash
A.S. Sree Viswarubhiny;
Susmita Chowdhury;
K. Jeya Prakash
A. Mohamed Hameed Aslam
K. Manoj Kumar
- Funding/ Fellowship Agencies : Department of Biotechnology

Introduction

India is home to over 20 per cent of the world's visually challenged population. It is estimated that the prevalence of childhood blindness in India is 0.8 per 1000 Children under the age of sixteen. The most common causes of blindness in children in India are congenital anomalies and retinal dystrophies. Inherited retinal dystrophies (IRDs) comprise a group of retinal diseases underlying varied scale of vision impairment. Besides the marked genetic heterogeneity, IRDs are characterized by profound phenotypic variability, which creates a major barrier in establishing the precise clinical diagnosis. However, molecular genetics have enormously helped to identify the causal genetic variants and thus leads to accurate clinical diagnosis. Therefore, the project aims to understand the molecular basis of the most common IRDs including LCA, JXLR, and LHON as well as RB. Overall, this project targets to create a paediatric genetic testing panel and database using evidences from integrated clinical and genetic data. This integrated approach will be beneficial for the patients and families by providing better, faster and cost-effective methods of diagnosis, risk prediction, and possible treatment options.

Comprehensive genetic analysis of Leber Congenital Amaurosis

Leber Congenital Amaurosis (LCA) is a severe visual impairment responsible for infantile blindness, representing approximately 5% of all inherited retinal dystrophies. LCA encompasses a group of



heterogeneous disorders, with 29 genes currently implicated in pathogenesis. LCA's clinical symptoms are very often similar to other retinal dystrophies, so the accurate clinical diagnosis, especially in infants, sometimes cannot be made at the first visit or has to be revised once the molecular analysis is performed. Genetic-molecular testing is necessary to obtain a definitive diagnosis of LCA through the identification of a pathogenic variant.

Therefore, the current study aims to reveal the genetic etiology of south Indian LCA patients using panel-based targeted sequencing. A targeted panel composed of 29 known LCA candidate genes was established and utilized to screen 109 unrelated south Indian LCA patients. The data were analyzed using an in-house bioinformatics pipeline and identified mutations as per the ACMG guidelines. Segregation analysis was also performed on the family members through Sanger sequencing. In addition, all patients in whom no mutations were identified by targeted sequencing were subjected to whole-exome sequence analysis.

Among 109 patients, 91 were identified with mutations in 19 known LCA candidate genes, of which forty patients possessed novel mutations. The mutation detection rate was 83%, consisting of 60% pathogenic, 18 % likely pathogenic and, 22% variants of uncertain significance. More than three-quarters of the patients with clinical LCA diagnosis confirmed by the results of molecular analysis, appeared to be affected with a severe form of the disease. The remaining 18 patients with no mutation underwent whole-exome sequencing, where 9 of them identified with variations in genes responsible for other retinal

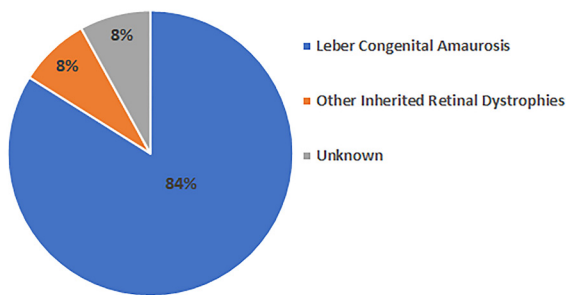

Figure 1: Clinical classification of 109 patients based on genetic diagnosis

dystrophies includes retinitis pigmentosa, stargardt diseases, and macular dystrophy (Figure 1).

From this study, we conclude that targeted sequencing with an expanded gene panel has significantly increased the mutation detection rate to 83%. Our study also expands the mutational spectrum based on the identification of 40 novel mutations in known LCA genes. Mutations in

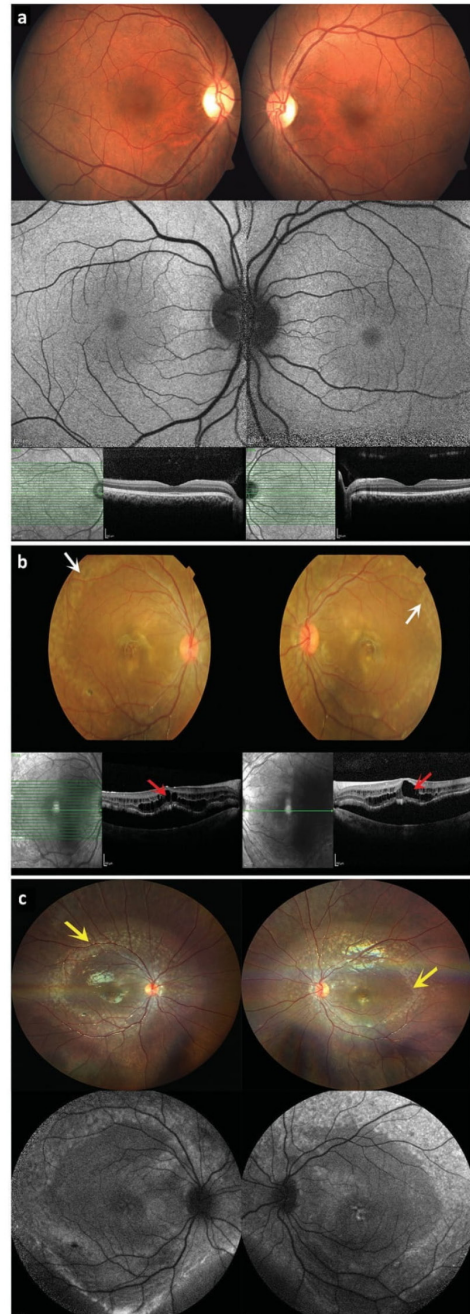

Figure 2. Clinical images of the proband. (a) Representative clinical image of the normal control. (b) Proband's fundus and OCT findings documented in 2016 (age 7 years). Color fundus images showed numerous faint subretinal vitelliform lesions and pigmentary changes surrounding the arcade (white arrows), few foveal vitelliform lesions and spoke wheel like pattern at macula of both eyes. OCT imaging showed the presence of intra-retinal cystic changes at the level of inner nuclear (INL) and outer plexiform layer (OPL) (red arrows). Presence of subretinal fluid was also observed. (c) Fundus, FAF and OCT findings documented in 2020 (age 11 years). Color fundus imaging revealed bilateral prominent subretinal vitelliform lesions surrounding the arcades (yellow arrows), which circumferentially covers the posterior pole. Fundus auto-fluorescence (FAF) showed hyper- autofluorescence at these areas

unscreened deep intronic and regulatory regions of the known LCA genes might contribute to a small percentage of disease etiology. Moreover, molecular diagnosis helps to understand the genetic etiology, which would further help to provide an accurate clinical diagnosis, genetic counseling and pave the way for gene therapy.

Whole-exome sequencing uncovers novel BEST1 mutation associated with bestrophinopathy and consequent Clinical reassessment:

Mutations in BEST1 gene (OMIM 607854) have been associated with five distinct inherited retinal disease phenotypes comprising best vitelliform macular dystrophy (BVMD), adult onset vitelliform macular dystrophy (AVMD), autosomal dominant vitreoretinopathy (ADVIRC), autosomal recessive bestrophinopathy (ARB), and autosomal dominant recessive retinitis pigmentosa (adRP), which are collectively known as bestrophinopathies. Although these clinical presentations are distinct, still immense phenotypic heterogeneity exists.

Autosomal recessive bestrophinopathy (ARB) is a form of bestrophinopathy with characteristic autosomal recessive inheritance due to the presence of compound heterozygous BEST1 mutations, though homozygous mutations have also been reported. Archetypal best disease-related fundal changes are lacking in ARB, instead observed with multifocal deposits, fluid accumulation along subretinal spaces, and abnormal autofluorescence. An estimated prevalence of 1:1 000 000; age onset for ARB has been reported as early as four years to adults of 40 years, though typical onset is juvenile.

In the current study, we described a 7 years old proband (fundus and OCT evaluations were shown in Figure 2) with a presumed provisional diagnosis of juvenile X-linked retinoschisis (JXLR), albeit lacking the RS1 gene mutation. Therefore, a trio whole-exome sequencing (trio-WES) approach was used for molecular diagnosis in this South Indian family with varied clinical presentations. Through careful molecular analysis and ocular reassessments, this study reports a novel pathogenic homozygous mutation in exon 4 of the BEST1 gene (c.G310A p.D104N) in the proband who displayed an ARB phenotype. Parents had heterozygous genotype

To seek structure-based functional consequences, BEST1 wildtype and mutant 3D structure was modelled using modeller. Residue D104 is located in the cytoplasmic domain of the protein. The substitution of Asp (D) residue to Asn (N) at codon position 104 breaks the hydrogen bond at S108 residue, potentially decreasing in molecule

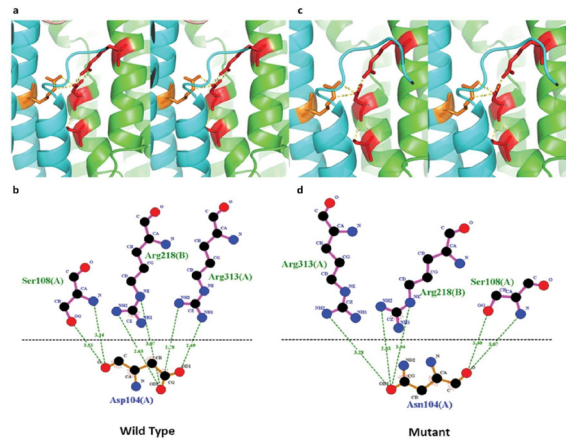

Figure 3: Representation of human bestrophin 1 modeled 3D structure comparison for wild type and mutant (Asp104Asn). (a) Left panel shows 3D stereo image and (b) corresponding interactions at position 104 for the wild-type protein. (c) Right panel illustrates mutant protein structure and (d) proposed interaction between Asn104 (mutated residue) and neighboring residues. Hydrogen bonds between the neighboring residues are indicated by the yellow and green dashed lines in the 3D and 2D structures. In comparison to wild type, alterations in bond lengths were observed in the mutant structure at Ser108 residue.

flexibility and destabilize the protein. Alteration in bond lengths of the interacting residues was also observed (Figure 3).

To summarize, to best of our knowledge, this study reports a novel pathogenic homozygous BEST1 mutation in a proband with clinical phenotype of ARB who was initially diagnosed as JXLR, thus augments the BEST1 mutation spectrum. This study also emphasizes the effectiveness of genetic testing, herein WES and careful ophthalmic observations to resolve the clinical phenotype culminating into correct diagnosis, improved conversation with patients for better prognosis and genetic counseling.

Mito-nuclear genes involvement in LHON patients:

LHON is a mitochondrial disorder that causes selective degeneration of retinoganglion cells due to bioenergetic failure of the electron transport complex I of the mitochondria. Mitochondrial complex I deficiency shows extreme genetic heterogeneity and can be caused by mutation in either nuclear-encoded genes or in mitochondrial-encoded genes. According to the recent reports, approximately 23% of childhood respiratory chain deficiency cases are caused by autosomal recessive mitochondrial complex I deficiency (MCID). In 2020, our lab has conducted a hospital-based five-year prospective study on LHON and revealed only 43.6% of the affected individuals harbor primary mtDNA mutation. Consequently, the remaining 56.4% of LHON may be attributed to either

secondary mitochondrial DNA mutations or with the nuclear gene mutations that regulating mitochondria.

In this context, we have carried out a pilot study using mitogenome and whole exome sequencing in order to understand the pathogenesis of LHON. Overall, we analyzed 30 samples to uncover mutations in the mito-nuclear gene in LHON patients through a Whole exome and mitogenome sequencing. All 30 samples were clinically diagnosed as LHON. Whole mitochondrial DNA sequencing results displayed 9 out of 30 samples were positive for primary mitochondrial DNA mutations ND1 (n=3); ND4 (n=3) and ND6 (n=3) respectively. Twelve samples were positive for secondary mitochondrial DNA mutations associated with LHON, and nine other samples showed no mutations in mitochondrial genome. Whole exome sequencing of these 30 samples revealed that 12 of the 30 were positive for nuclear gene mutations regulating mitochondria associated with LHON. Among the 12 samples, 6 were positive for only nuclear gene mutations, and the remaining 6 samples were positive for both nuclear and secondary mitochondrial mutations. The localization of the mito-nuclear gene mutations in mitochondria are represented in Figure 4. Even though 86.7% of our study participants had either a mitochondrial or nuclear gene mutation, 13.3% had no mutations in both nuclear and mitochondrial genomes, indicating a need for a whole genome sequence to better understand the pathogenic features associated with LHON like optic neuropathy.

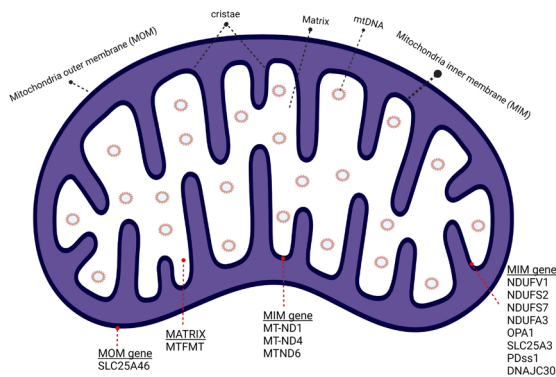

Figure 4: Representation of the localization of the mito-nuclear genes identified by whole exome sequencing in mitochondria

Development of transmitochondrial cybrid cell model to study mtDNA mutations in LHON:

Mitochondrial functions are controlled by both mitochondrial DNA (mtDNA) and nuclear DNA. Hence, it is difficult to identify whether mitochondrial or nuclear genome is responsible for a particular mitochondrial defect. Present study employs transmitochondrial cybrids as an alternative model

system, where we can compare mitochondria from different sources in a defined nuclear background. Cybrids are constructed by fusing platelets harboring wild type or altered mtDNA of interest with Rho-0 (ρ -0) cells (cells lacking mtDNA) in which the endogenous mtDNA has been depleted.

Plasmid DNA containing mitochondrial targeted human uracil-N-glycosylase mutant gene (hUNG1 Y147A/mUNG1) was reported to cause mtDNA depletion. mUNG1 can attack any accessible region of mtDNA and induce damage by cleaving off thymines thus creating abasic sites and create mtDNA double-strand breaks and therefore degradation. Observed physiological changes (Rho-0 phenotype) are secondary to reduced expression of mitochondrial polypeptides. The plasmid vector was procured and transformed into DH5 α cells for scale up. About 5 μ g of plasmid DNA was transfected in 143B TK- cells. The transfected cells were selected by treating the cells with G418. Presence of mtDNA was checked by performing PCR for the mitochondrial DNA. The Rho-0 cells were further expanded and fused with platelets using 45% polyethylene glycol to create transmitochondrial cybrid cells. The DNA was extracted from cybrid cells

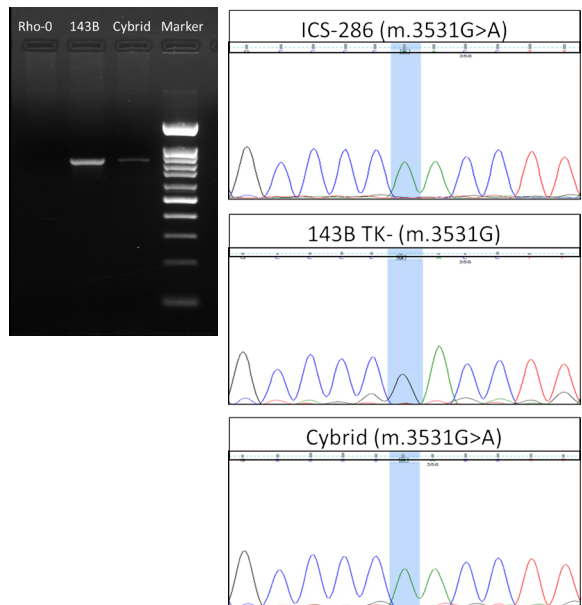

Figure 5: Validation of transmitochondrial cybrid. Left: Agarose gel shows the absence of mtDNA content in the Rho-0 cells, presence of mtDNA content in the 143B TK- control cell line and the Cybrid cells. Right: Chromatogram shows the presence of donor specific mtDNA variant m.3531G>A in the cybrid cells.

and validated through PCR for the mtDNA content and the specific mtDNA variant was confirmed by sanger sequencing (Figure 5).

Conclusion

We have successfully developed the cybrid model to study the functional effects of mtDNA mutations in a defined nuclear background. Further, cybrid cells will be created by fusing rho-0 cells with platelets derived from LHON patients and functional studies will be performed to validate the mtDNA mutations by measuring ATP production, ROS production and mitochondrial membrane potential.

RETINOBLASTOMA

Clinical and Genetic characteristics of Retinoblastoma

The clinical features of 160 RB patients diagnosed during the last 3 years were analysed. Among the 160 patients, 111 had unilateral RB (69.8%) and 49 had bilateral RB (30.2%). Only nine patients had positive family history and others were sporadic. There were 87 females and 73 males. The mean ages (mean \pm STD) of diagnosis were 28.87 ± 3.527 and 18.15 ± 4.396 months for unilateral and bilateral RB, respectively. Almost all of them (154/160) were diagnosed with RB under the age of five years. The majority of the RB patients (134/160) presented with leukocoria (white reflex) as the first clinical sign followed by squint, redness, proptosis, and defective vision. The presence of tumors by radiological investigations was identified in inferotemporal regions in the majority of patients followed by superonasal.

Clinical examinations identified a total of 210 eyes from 160 patients as tumor-bearing eyes. Representative clinical characteristics were shown in Figure 1. These 208 eyes, according to the International Classification of Retinoblastoma grouping, were grouped into A (n=11), B (n=20), C (n=12), D (n=36), and E (n=131), signifying that majority of the patients are diagnosed at late stages of the disease. Of 208 eyes, 129 eyes underwent enucleation as a part of treatment either primary or secondary. Hematoxylin-eosin staining of the enucleated eyes showed 66 well-differentiated,

47 poorly differentiated, and, due to treatment, 16 regressed/calcified eyes. In addition, intraocular invasions included choroid (n=89), RPE (n=31), optic nerve (ONH) head (n=85), ciliary (n=3), iris (n=2) and sclera (n=2) were also observed. ONH invasions included prelaminar (n=41), laminar (n=16), retrolaminar (n=28). Also, all enucleated tumor-eye balls, according to pT-staging, were further grouped into low-risk (pT1/2, n=60) and high-risk (pT3/4, n=69) groups.

The combined analyses of *RB1* gene detected mutations in 114 out of 160 retinoblastomas, which included 64 with germline mutation (heritable) and 50 with somatic mutations (nonheritable). Germline mutations were identified in 19 of 111 unilateral cases (17%) and 44 of 48 (92%) bilateral cases. The overall spectrum of *RB1* mutations is represented in Fig 2. which included nonsense (28%), splice (25%), large/exonic deletions (20%), frameshift (18%), missense (8%), promoter methylation (3%) and intronic (1%). Excluding large/exonic deletion and promoter methylation, 75 unique mutations were identified in

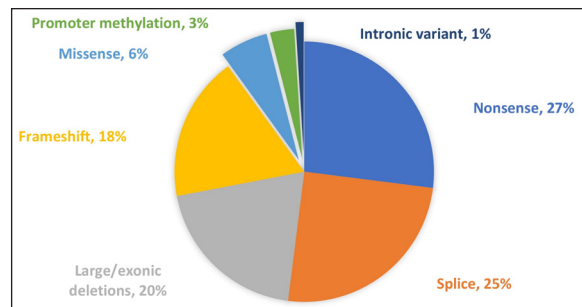

Figure 2: Mutational spectrum of *RB1* in retinoblastoma patients

our cohort along with 10 recurrent mutations. Among 75 unique mutations, 22 were novel that included frameshift (n=17), splice (n=3), missense (n=1), and intronic (n=1). *RB1* genetic/epigenetic aberrations were not detected in four RB tumors.

Figure 1: Clinical characteristics of RB - Representative clinical image of a Retinoblastoma tumor shown by large mass (Group D) in Retcam (left) and MRI image (Middle) and as rosettes in H & E staining (right)

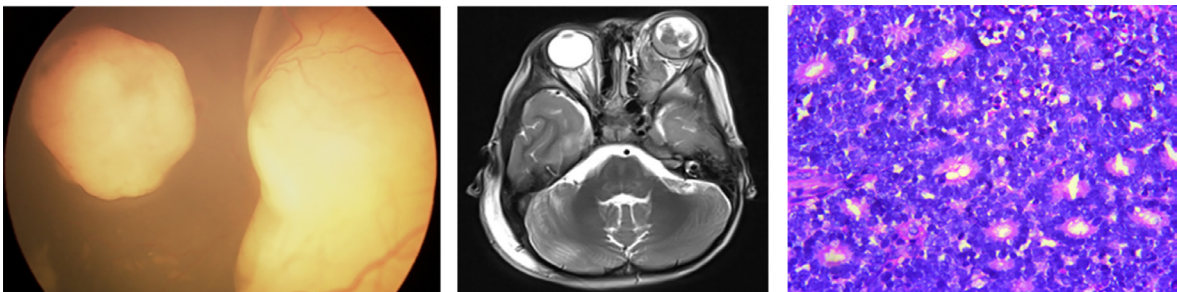

Table 1: Clinico-histopathological correlation between heritable and nonheritable RBs

Clinical/histological features		Heritable	Non-heritable	p value
Laterality	Unilateral	19	49	<0.0001
	Bilateral	44	1	
Gender	Male	29	21	0.8494
	Female	35	29	
Risk-factor	pT1/2	26	17	0.0098
	pT3/4	14	31	
Differentiation pattern	Well differentiated	37	26	<0.0001
	Poorly differentiated	6	28	
Mean age of diagnosis		18.88	30.1	<0.01

Genotype-phenotype correlations in retinoblastoma

RB patients with mutations were included for genotype-phenotype correlations. Here, clinical and histopathological features were correlated between patients with heritable and nonheritable mutations (Table 1). Fisher-exact and Chi-square tests were used for countable variables and column statistics was used for continuous variables. All Statistical tests were performed using Graphpad prism 7.

Gender proportion was not different between heritable and nonheritable ($p=0.8494$). Heritable RBs were diagnosed at earlier ages (18.88 months) than nonheritable RB (30.1 months). Unilateral RB

were mostly nonheritable whereas bilateral were heritable ($p<0.0001$). Pathological high-risk factors were significantly associated with nonheritable RB ($p=0.0098$). Significant association was found between poorly differentiation and nonheritable RB ($p=0.0001$). There was no significant association between different types of RB1 mutation with either heritable or nonheritable RBs ($p=0.5298$).

Genomic alterations in retinoblastoma tumors:

Though *RB1* inactivation is the hallmark of retinoblastoma development, several studies supported additional genetic alterations at chromosome or gene level are mandatory for the successful progression of the tumor in

Table 2: Copy number alterations of cancer-associated genes in retinoblastoma

Chromosome	Genes	Somatic alterations	Percentage (%)
chr1	<i>MDM4</i>	Copy number gain	46
chr16	<i>CDH11</i>	Copy number loss	46
chr16	<i>CDH13</i>	Copy number loss	46
chr6	<i>DEK</i>	Copy number gain	40
chr6	<i>E2F3</i>	Copy number gain	37
chr1	<i>KIF14</i>	Copy number gain	34
chr20	<i>SRC</i>	Copy number gain	31
chr20	<i>GATA5</i>	Copy number gain	31
chr13	<i>RB1</i>	Copy number loss	29
chr11	<i>HRAS</i>	Copy number gain	20
chr19	<i>MAP2K2</i>	Copy number gain	20
chr2	<i>ALK</i>	Copy number gain	20
chr7	<i>SMO</i>	Copy number gain	17
chr20	<i>E2F1</i>	Copy number gain	17
chr19	<i>STK11</i>	Copy number gain	17
chr17	<i>ERBB2</i>	Copy number gain	10

Figure 3: Clinical targets regulating MAPK signaling pathway.

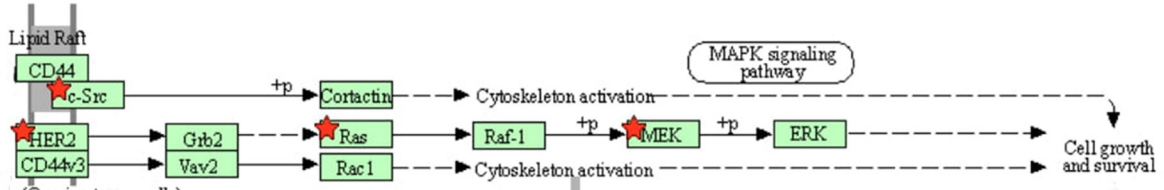

retinoblastoma. Hence, targeted exome panel inclusive of cancer associated genes along with successful clinical targets was designed. Totally, 38 RB samples (3 primary cells, 35 tumors) with matched blood controls were subjected to targeted exome sequencing using Miseq platform and the raw data were analysed using in-house pipeline to identify the potential pathogenic variants and copy number alterations were determined using average depth coverage. These pathogenic alterations were correlated with clinico-pathological features using Graphpad prism 7.

Copy number analysis revealed alterations in cell cycle related genes such as *E2F3*, *KIF14*, *DEK*, *MDM4* as well as cell-adhesion genes *CDH11* and *CDH13* in 35 to 45% of RB samples, that were involved in RB tumor progression. Additionally, copy number alterations of clinical targets such as *SRC*, *HRAS*, *MAP2K2*, *ALK*, *SMO*, *ERBB2* were also found in these RB samples paving to new way for RB treatment (Table 2). These genes were well-known targets of bladder and non-small lung cancers. David-tool analysis revealed these genes regulate MAPK signaling pathway (Figure 3), suggesting small molecule inhibitors could be used target this pathway for improved treatment

Epigenetic mechanisms underlying tumor progression in retinoblastoma

It is now known that epigenetic mechanisms play a major role in tumor progression through the regulation

of the expression in cancer associated genes. The epigenetic events regulating the tumor progression were dissected by genome-wide methyl array. The methylation analysis was carried out using an R package with GUI "ShinyEPICo". Illumina Infinium® Methylation EPIC 850K Array that can quantify methylation at 850,000 different CpG sites was carried out. Totally, 16 samples including 8 RB tumors with 5 matched surrounding tissues, 2 normal retinal tissues and a cell line were taken for methylation analysis. For the further analysis, 7 RB tumors and 2 normal retinal tissues with complete data were used.

After the analysis, 64,807 differentially methylated CpGs with statistical significance [39075 (Hypomethylated) and 25732 (Hypermethylated)] were identified using criteria: $\Delta\beta > 0.2$, $FDR < 0.05$, $p\text{-value} < 0.05$. The differential methylated CpGs were fed into the GREAT tool that aids in finding the function of cis-regulatory regions. The hypermethylated CpGs were enriched with the vision associated pathways like rhodopsin mediated signaling pathway, photo transduction pathways, as shown in Figure 4. This aberrant regulation of visual development process through epigenetics was suggested as molecular aetiology in RB and our data confirm the loss of the genes in photo transduction pathway through hypermethylation.

Hypomethylated CpGs were enriched with the biological processes like regulation of transcription, glucose metabolism as shown in Fig.5. Enrichment

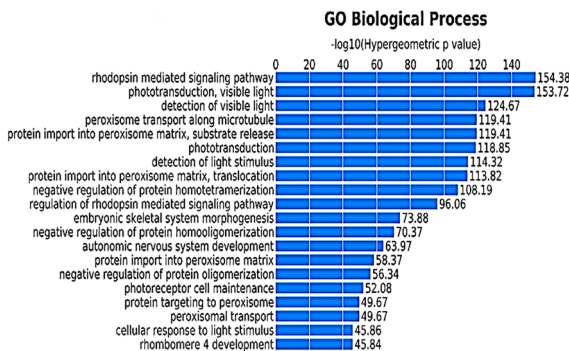

Figure 4: Bar plot showing the top 20 pathways enriched for the hypermethylated genes

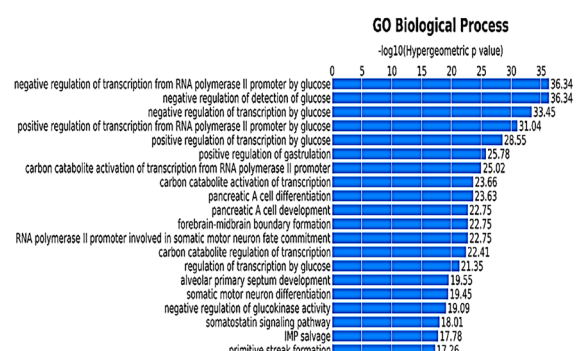

Figure 5: Bar plot showing the top 20 pathways enriched for the hypomethylated genes

of these hypomethylated genes implies their role in uncontrolled cell proliferation by active transcription in retinoblastoma tumors.

Alternate animal model for functional validation of candidate genes in retinoblastoma:

Basic semi-automatic zebrafish housing system was established for the functional validation of the genetic alterations. Fifty pairs of wild blue line zebrafishes were purchased from supplier and are maintained under aseptic conditions, according to

animal handling ethics. Breeding conditions were optimized. Briefly, Male and Female (1: 2) zebrafishes were separated with divider in the breeding tank and divider was removed for overnight. Next day, embryos were collected and segregated the fertilized embryos alone. Embryos were monitored using stereozoom microscope for 72 to 84 hour post fertilization (Figure 6). Orthotopic model for retinoblastoma will be developed and drugs against the identified candidate genes will be screened.



Figure 6: (a) 0 to 16 hour post fertilization (b) 24 to 48 hour post fertilization and (c) 72 hour post fertilization.

GENETICS OF OCULAR TUMORS

Ocular tumors can affect the various parts of the eye and it can be benign or malignant. The diagnosis of ocular tumors is always challenging as there are no obvious symptoms in many instances. A detailed evaluation that includes clinical, radiological, histopathological and genetic investigations is essential for accurate diagnosis. Even after the proper diagnosis, the treatment remains as an enigma due to diverse clinical course, differential response to the drugs, recurrence and metastasis of the disease. Our research focused on retinoblastoma and lymphoma had addressed some of these clinical problems and helped the patients, families and treating clinicians towards the quick diagnosis and better treatment strategies.

Genetic Testing of Retinoblastoma

Investigators : Dr. A. Vanniarajan, Dr. Usha Kim, Prof. VR. Muthukkaruppan
Project Fellows : V. Senthil Nathan, K. Murugan
Funding Agency : Aravind Eye Care System, Madurai

Introduction

Retinoblastoma is the most common intraocular malignancy in children. *RB1* gene inactivation is the hallmark of the retinoblastoma. The gene inactivation can be caused by base substitutions, indels, deletions/duplications and promoter methylation.

Multiple methods such as Sanger Sequencing, Multiplex Ligation dependent Probe Amplification, Bisulphite Sequencing and Next Generation Sequencing were developed in the lab to identify the wide spectrum of variants.

Results

During the last year, *RB1* gene variations were analysed in 64 patients from different geographical locations across the country. Apart from the spectrum of variants mentioned, splice variants were identified as a result of the extended analysis which could be missed otherwise. One sample with intronic variant and other with no detectable *RB1* mutation at DNA level, showed structural alterations at mRNA level. First sample showed partial retention of intron 9-10 leading to premature truncation (Fig 1) whereas second sample showed three distinct mutant bands at mRNA level, resulting in skipping of exon 22 and skipping of exon 21 and 22, both results in premature protein truncation (Fig 2).

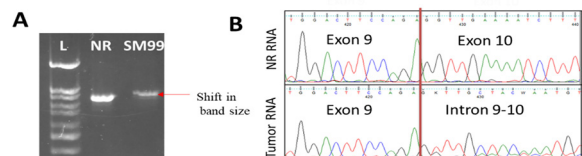

Figure 1: (a) PCR amplification showing mutant band with little higher molecular weight compared to neural retina (NR). (b) Partial intron retention 9-10 at mRNA level



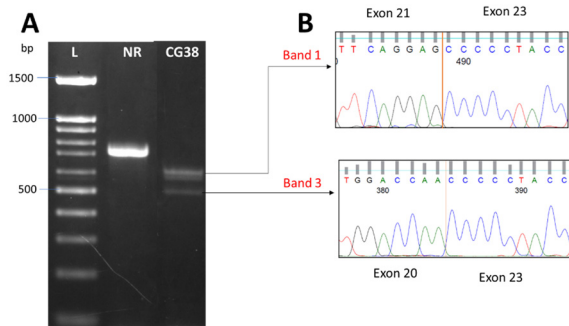

Figure 2: (a) PCR amplification showing three mutant bands compared to neural retina (NR). (b) Band 1: skipping of exon 22 and band 3: Skipping of exon 21 & 22.

Conclusion

The extended transcript analysis of *RB1* gene aided to determine the effect of splicing-defect mutation at transcript level. It also revealed the structure alterations of *RB1* in tumors with no detectable *RB1* mutations. This strategy has improved our understanding of deep intronic variants and increased mutation detection rate.

Genomic characterization of kinome related genes in retinoblastoma

Investigators : Dr. A. Vanniarajan,
Dr. Usha Kim,
Prof.VR. Muthukkaruppan
Research scholar : K. Jeyaprakash
Funding agency : Department of Biotechnology

Introduction

Cancer is a complex phenomenon with interplay of many genes. The tumor progression in

retinoblastoma is suggested to be facilitated by various signal transduction pathways of RB regulated by protein kinases via phosphorylation. Phosphorylation is one of the post translational modifications that govern numerous cellular processes such as cell growth, proliferation and differentiation. Kinases and phosphatases together regulate the phosphorylation of several proteins in a cell. This project examines the kinome related genes involved in tumorigenesis of retinoblastoma.

Results

A targeted panel with cancer-associated genes having many druggable kinase genes was designed. The analysis of 35 RB tumors showed many pathogenic mutations other than *RB1* as shown in Fig 3.

In addition, several recurrent copy number alterations were found in promising targets such as *SRC*, *HRAS*, *ALK*, *MAP2K2* and *ERBB2*. Small-molecule inhibitors targeting these genes were obtained (Table 1).

Table 1: Small-molecule inhibitors chosen for in vitro validation of candidate genes

S.No	Small molecule kinase inhibitors	Molecular Targets (Our panel genes)
1	Dasatinib	<i>SRC</i>
2	Bosutinib	<i>MEK1</i> , <i>MEK2</i> , <i>SRC</i>
3	Lapatinib	<i>ERBB2</i>
4	Afatinib	<i>ERBB2</i>
5	Trametinib	<i>MAP2K2</i>
6	Ceritinib	<i>ALK</i>

Figure 3: Frequencies of somatic and germline mutations identified in RB tumors apart from *RB1* mutations

Frequencies of somatic mutations beyond *RB1*

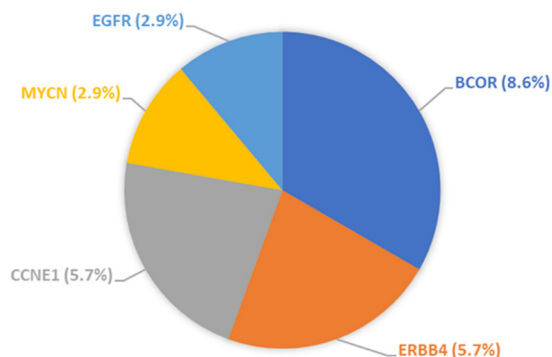

Frequencies of germline mutations beyond *RB1*

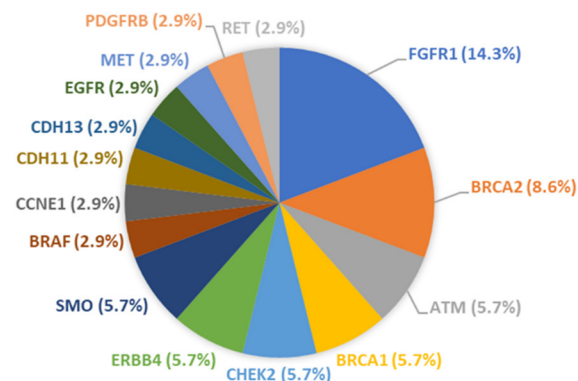

Conclusion

Mutations and copy number variations were identified in the kinase genes. FDA approved drugs for the specific kinases were chosen. RB cell lines and primary cultures will be screened with the drugs and expression levels will be checked to confirm the effect of the drugs.

Understanding the molecular mechanisms of chemoresistance in retinoblastoma

Investigators : Dr. A. Vanniarajan,
Dr. Usha Kim,
Prof. VR. Muthukkaruppan
PhD Scholar : T.S. Balaji
Funding Agency : Council of Scientific & Industrial
Research (Fellowship)

Introduction

Chemoresistance remains as a major problem in treating the retinoblastoma patients. The resistant cell line models were developed last year to study the factors responsible for chemoresistance. However, these cell line models cannot replicate the tumor microenvironment. In order to study the molecular factors in the condition mimicking the actual tumors, it is important to establish the primary culture from the tumor samples.

Results

The tissue was disaggregated and incubated with (1) the stem cell defined media and (2) undefined DMEM formulated growth medium. Tumor cells in stem cell defined media had appeared as a clump of cells resembling tumorspheres within 3-4 weeks of incubation. In contrast, cells grown in FBS containing DMEM medium gave rise to highly proliferating adherent cells resembling the spindle-shaped morphology of a fibroblast (Figure 4).

Figure 4: Morphology of Primary RB Cells Derived from an RB patient. Arrowhead shows the origin of the (a) tumorspheres and (b) fibroblast. (c) Fully grown tumorsphere (d) Fibroblast culture

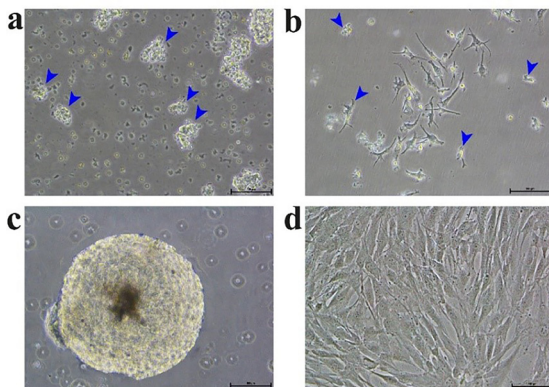

Conclusion

The primary culture established will be useful for all the functional studies including the screening of the drugs identified by the various other molecular studies as they mimic the actual conditions of the tumor.

Molecular characterization of tumor progression in Retinoblastoma

Investigators : Dr. A.Vanniarajan,
Dr. Usha Kim,
Prof. VR. Muthukkaruppan
PhD Scholar : T. Shanthini
Funding Agency : DST-INSPIRE (Fellowship)

Introduction

Non-genetic mechanisms play a major role in retinoblastoma in addition to the genetic events. MicroRNAs were analysed in retinoblastoma tumors to identify their role in tumor progression.

Results

RNA samples from 7 RB Tumor and 3 control tissues were taken for miRNA profiling. Based on the abundance of reads and relevance, 246 miRNAs were filtered (Fig.5). Eleven miRNAs (6 down regulated and 5 up regulated) were found to be significant and consistently differentially expressed in all the tumors. The miR-125a-5p was shown to inhibit the tumor progression of retinoblastoma by suppressing the EGFR pathway. The other miRNAs hsa-miR-25-3p and hsa-miR-449a were shown to play a role in cell growth, colony formation and cell migration.

Figure 5: Volcano plot showing the differentially expressed miRNAs of statistical significance

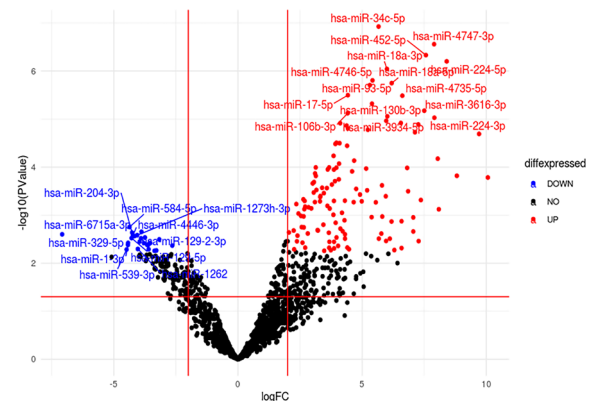

Conclusion

Several microRNAs were found to be differentially regulated in Retinoblastoma. Transcriptome sequencing and further integration of the microRNA data will show the regulatory role of the microRNAs.

Identification and Validation of Dysregulated Pathways in Retinoblastoma

Investigators : Dr. A. Vanniarajan, Dr. Usha Kim, Prof. VR. Muthukkaruppan
Project Fellows : T.S. Balaji
Funding Agency : DST-SERB

Introduction

With advent of gene expression profiling techniques, the cancer aetiology and biomarkers have vastly been studied. The present study is aimed at investigating the expression profile of genes, involved in cancer-specific pathways in RB tumors using a real-time PCR based array with multiple internal controls.

Results

During the last year, Six genes (*CDC20*, *MCM2*, *MK167*, *PGF*, *WEE1* and *COX5A*) were found to be deregulated in 13 tumors using PCR Array. In this year, the expression of these genes was further

confirmed by RT-qPCR with another set of samples (10 neural retinal and 15 RB tumors). Both invasive and non-invasive RB tumors were selected, however, there was no statistical difference among these two groups. *COX5A* was down regulated, whereas *CDC20*, *MCM2*, *MK167*, *WEE1* and *PGF* were up regulated (Figure 6).

Conclusion

In this targeted transcriptome analysis of cancer-related genes, we identified transcriptional alterations in *CDC20*, *MCM2*, *MK167*, *PGF*, *WEE1* and *COX5A* in all the tumors studied. This extensive analysis of gene expression by RT-qPCR corroborated the PCR array data. Therefore PCR Array can be utilized for rapid identification of transcriptional alterations in malignant tumors with no need of further validation.

Translational Genomics of Ocular Cancers

Investigators : Dr. A. Vanniarajan, Dr. Usha Kim, Dr. R. Shanthi, Dr. D. Bharanidharan, Prof. VR. Muthukkaruppan
Project fellow : K. Saraswathi, K. Jeyaprakash
Funding Agency : Aravind Eye Foundation, USA; Lady Tata Memorial Trust (Fellowship)

Figure 6. RT-qPCR validation of mRNA expression data obtained from PCR array.

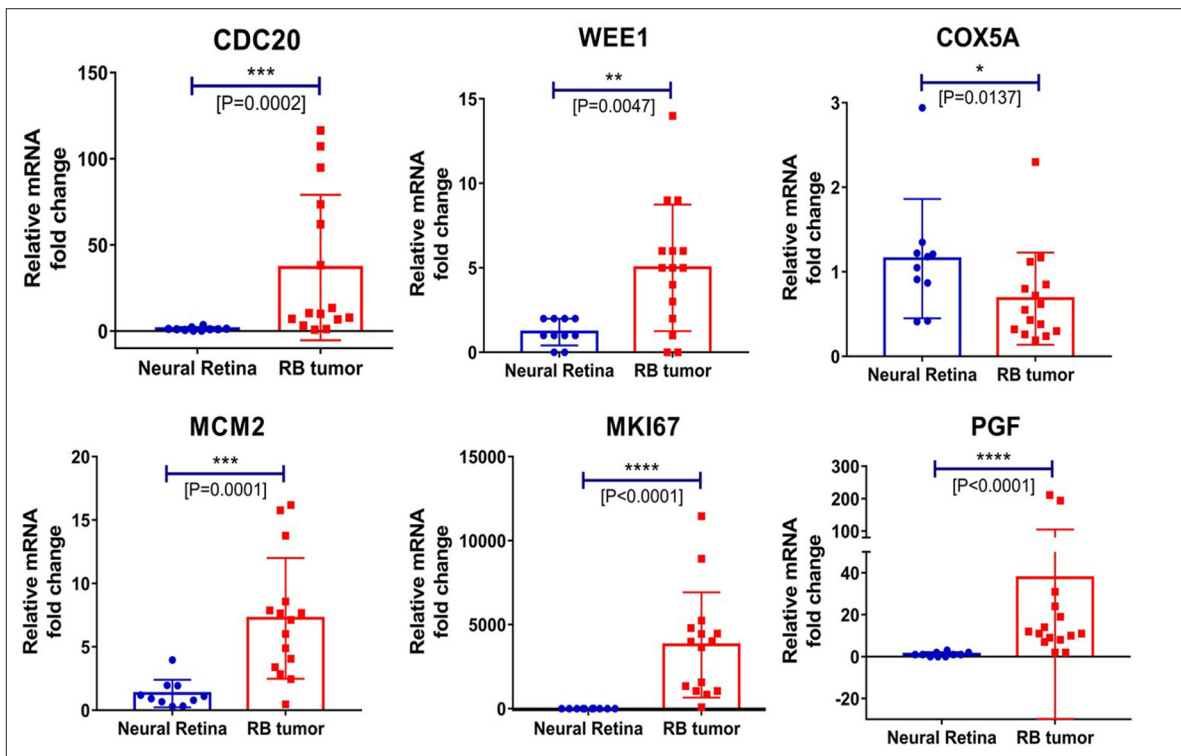

Introduction

A number of recurrent chromosomal aberrations and genetic lesions have been described in the pathogenesis of Ocular Adnexal lymphomas (OAL). However, the pathogenesis of OAL is still largely unknown. Hence a detailed molecular study is essential.

Results

Whole exome sequencing (WES) was performed for 11 samples of OAL (6 matched control). Clinical data of the cohort and detailed characteristics of the patients are shown in table 2. The WES analysis revealed an average of 134 somatic variants on stringent filtering criteria (Figure 7). The mutational state of known lymphoma associated genes and homozygous variants were obtained (Table 3). Mutations in *TNFAIP3*, *MYD88*, *CD79B* and *BCL6* genes were found to be involved in the regulation of BCR signalling pathway which consecutively activate several signalling pathways. The other pathogenic variants *TP53*, *CASP9*, *CDKN2B*, and *EP300* were found to be involved in the dysregulation of cell cycle and NFkB pathway.

Table 2: Clinical characteristics of the OAL patients

Characteristics	No. of Patients
Age of diagnosis (Years) Median	64
Range (Years)	(30-85)
Gender	
Female	5
Male	6
Location	
Superior	5
Inferior	4

Both the quadrants	2
Histopathology	
B cell	11
T cell	-
Laterality	
Unilateral	11
Bilateral	-

Conclusion

A set of pathogenic variants that play an important role in the NFkB signaling pathway were observed in OAL. Further copy number analysis and expression studies will help to confirm these results to elucidate the molecular mechanism.

Targeted Modulation of E2F3 and KIF14 pathway in Retinoblastoma refractory to existing chemotherapeutic drugs

Investigators : Dr. A. Vanniarajan, Dr. Usha Kim, Prof. K. Dharmalingam
Project Fellow : R. Sethu Nagarajan

Introduction

Current systemic chemotherapeutic regimen was not much successful in retinoblastoma patients with late presentation. Earlier studies from the lab found frequent copy number gains of cell cycle modulators such as *E2F3* and *KIF14* which are well studied oncogenes. Targeting these cell cycle modulators could be a competent treatment approach for Retinoblastoma. In this study, small molecule inhibitors were tested against the target genes using the retinoblastoma cell lines.

Table 3: Overview of pathogenic variants in OAL prioritized by WES

Gene/Samples	LT01	LT03	LT04	LT05	LT06	LT08	LT09	LT10	LT11
<i>MYD88</i>									
<i>CD79B</i>									
<i>TNFAIP3</i>									
<i>EP300</i>									
<i>BCL6</i>									
<i>BCR</i>									
<i>HLA-DRB1</i>									
<i>TP53</i>									
<i>CXLR4</i>									
<i>CHEK2</i>									
<i>STAT3</i>									
<i>CDKN2B</i>									
<i>BIRC5</i>									
<i>PIMI1</i>									
<i>CASP9</i>									
<i>PIK3R1</i>									

Legend: Frame Shift (Blue), Non Sense (Yellow), Missense (Red), Splice (Green), Recurrent tumor (Orange), Primary tumor (Light Green)

Figure 7: Representative image of variant prioritization of WES

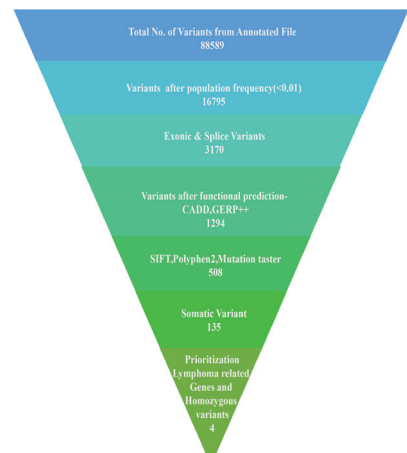

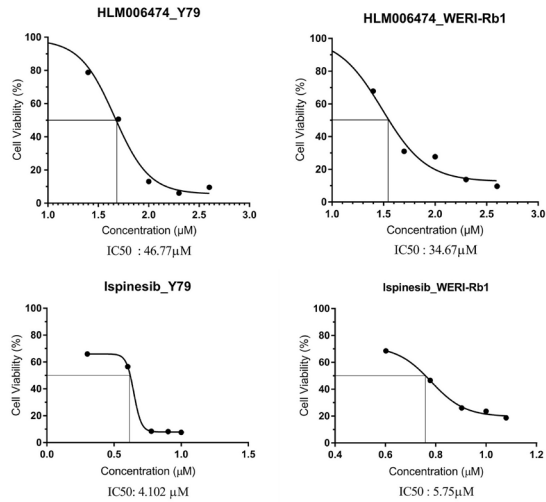

Figure 7: Determination of IC₅₀ for the drugs using retinoblastoma cell lines

Results

The Small molecule inhibitors HLM006474 were used to target *E2F3* and SB-715992 (Ispinesib) to target KIF14 and the cytotoxicity was determined by MTT assay. Cell density was optimized to be 20,000 cells/well. Y79 and WERI-Rb1 showed 50% inhibition at 46.77µM and 34.67µM concentration against the

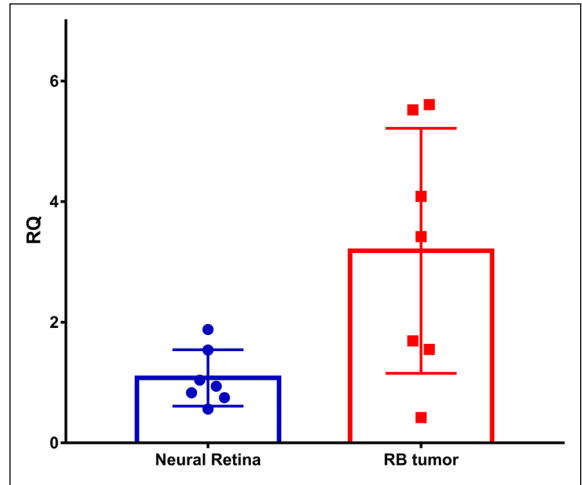

Figure 9: Increased expression of GD2 synthase in retinoblastoma tumors

HLM006474 respectively. Similarly, Y79 and WERI-Rb1 showed 50% cell growth inhibition at 4.107µM and 5.75µM concentration for Ispinesib respectively (Figure 8).

RT-qPCR results showed the decreased expression based on the concentration determined by MTT assay. Western Blot analysis also confirmed the down regulation of *E2F3* and KIF14 in treated cells compared to the untreated control cells (Figure 9).

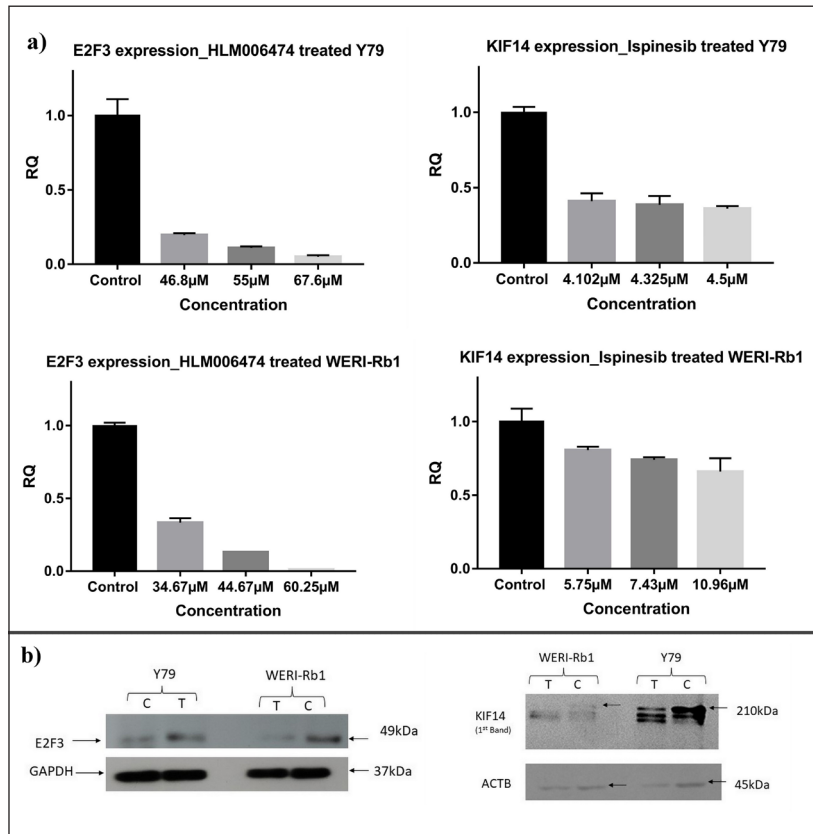

Fig. 8 Inhibition of targets with small molecule inhibitors: a) Reduced gene expression of *E2F3* and *KIF14* with the increasing concentration of the inhibitors b) Down regulation of *E2F3* and *KIF14* at the protein level with the inhibitor treatment

Conclusion

The inhibition of E2F3 and KIF14 with small molecule inhibitors was demonstrated in cell lines. Further, functional assays will be performed to understand the cellular mechanism.

Evaluation of GD2 synthase as a prognostic biomarker in retinoblastoma

Investigators : Dr. A. Vanniarajan, Dr. Santhi,
Dr. Usha Kim
Project Fellow : R. Sethu Nagarajan
Funding : VISTA

Introduction

The delayed presentation of retinoblastoma reduces the chance of treating the disease. In the advanced stage of the disease, there is a higher chance for CNS involvement and further metastasis to other sites. To evaluate the invasiveness, CSF cytology will be performed. But in case of minimal dissemination, there is a higher chance for false negative which will lead to the CNS relapse in future. Hence an effective biomarker that can indicate the invasion is essential. Earlier reports have suggested GD2 synthase as a biomarker for leptomeningeal dissemination. Hence, this study is aimed to develop a method to detect GD2 synthase in the tumor and CSF samples of retinoblastoma patients.

Results

A set of primers for GD2 synthase were designed and the PCR conditions were optimized. The expression of GD2 synthase was assessed in tumor samples.

RT-qPCR analysis was done in 7 tumors with optic nerve head invasion along with the non-RB cadaver neural retina samples. The expression of GD2 synthase were normalized with two housekeeping genes (*B2M* and *ACTB*). Increased expression of GD2 synthase was found in tumor samples compared to the control neural retina samples ($p=0.0017$) (Fig.9). The protocol for the isolation of RNA from the CSF samples were optimized.

For the analysis of the GD2 synthase in CSF, five patients with invasion were identified to confirm our results.

Table 4: Patients with invasion chosen for CSF analysis

Patient ID	Clinical presentation
CS1	Optic nerve invasion at time of presentation with CSF Mets after 1 year
CS2	No Intracranial invasion at presentation but had invasion after 2 years of noncompliance to treatment
CS3	Intracranial invasion at presentation
CS4	Intracranial invasion at presentation
CS5	Only prelaminar optic nerve head invasion at presentation, but had CSF Mets after noncompliance to treatment for 5 months

Conclusion

Overexpression of GD2 synthase in the tumor samples was identified. Further evaluation in CSF will confirm its utility in detecting the invasion and metastasis.

STEM CELL BIOLOGY

Adult tissue resident stem cells present in almost every tissue of the body play a significant role in the maintenance of tissue homeostasis throughout life. The focus of research in this department is to understand the basic biology of the adult ocular stem cells – their identification, location, niche or microenvironment, molecular regulation and role in the maintenance of tissue homeostasis. This basic research is essential to characterize the changes in these stem cells with ageing and in diseased condition, which is significant to develop better stem cell-based therapies for ocular conditions including limbal stem cell deficiency, primary open angle glaucoma, age-related cataract and retinal degenerative diseases.

Characterization of adult human lens epithelial stem cells in the maintenance of tissue homeostasis throughout life and their functional status in cataractous lens

Investigator : Dr. Madhu Shekhar
Co-PI : Dr. Gowri Priya Chidambaranathan
Prof. VR. Muthukkaruppan,
Dr. Haripriya Aravind
Research Scholars: P. Saranya, M. Lakshmi Priya
Funding agency : Science and Engineering
Research Board

Introduction including Background

The crystalline lens is entirely derived from a single cell type –the anterior lens epithelial cells. The

epithelial cells are known to differentiate into lens fibres throughout life. The location of stem cells in the lens epithelium remains controversial. Hence the study aims to identify and characterize the lens epithelial stem cells, their role in maintaining tissue homeostasis and in the development of age related cataract. The four zones in the human anterior lens epithelium were demarcated based on the expression of specific markers (Cx-43 and crystallins). The stem cells expressing SOX-2 but negative for Cx-43 were identified to be located only in the central zone. In continuation, studies were carried out in this year to analyse the changes in the lens epithelial stem cells in cataractous donor tissues. Further the importance of neural retina in inducing new lens fiber formation was established using whole lens culture.

Results

Loss of adult human lens epithelial stem cells in cataract

The cataractous donor lenses were identified based on the opacification/reduced transparency under stereozoom microscope. The whole mount of cataractous human anterior lens epithelium was immunostained for stem cell marker SOX-2 along with the differentiated cell marker Cx-43 to identify the adult stem cells. Confocal analysis of the immunostained whole mount revealed the negative expression of SOX-2 in the nucleus. Nuclear blebbing was observed in a proportion of cells in the central zone and these blebs were positive for SOX-2 (Figure 1). Lens epithelial cells in the other zones were negative for SOX-2 but positive for Cx-43.



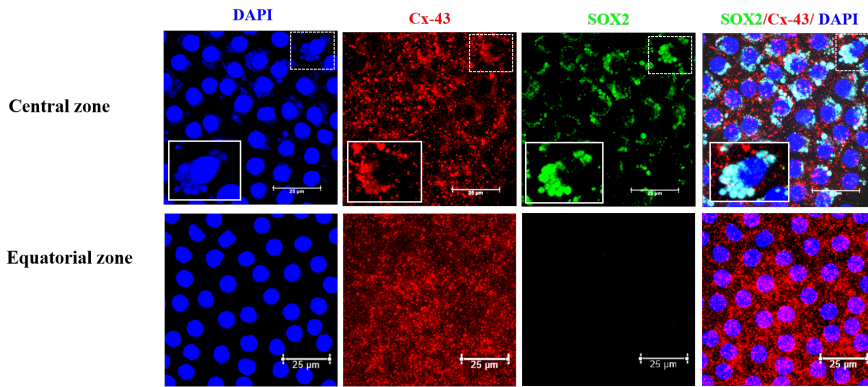

Figure 1: Representative confocal microscopic images of human anterior lens epithelium from a donor with cataract, double immunostained for stem cell marker SOX-2 and differentiated cell marker Cx-43. The nuclear expression of SOX-2 was negative in the central zone. The nucleus of cells in the central zone showed bleb formation and the blebs were positive for SOX-2 expression.

In order to elucidate the association of nuclear blebs with apoptosis, TUNEL assay was performed. The fragmented nucleus and its blebs were positive for TUNEL indicating apoptotic cell death (Figure 2). Nuclear blebbing was observed in $39.8 \pm 13.1\%$ of cells in the central zone but not in other zones and such cells were confirmed to be apoptotic by the expression of TUNEL. Among the cells with nuclear blebs, $11.8 \pm 4.1\%$ were negative for Cx-43.

The epithelial cells in the equatorial zone were negative for SOX-2 but positive for Cx-43.

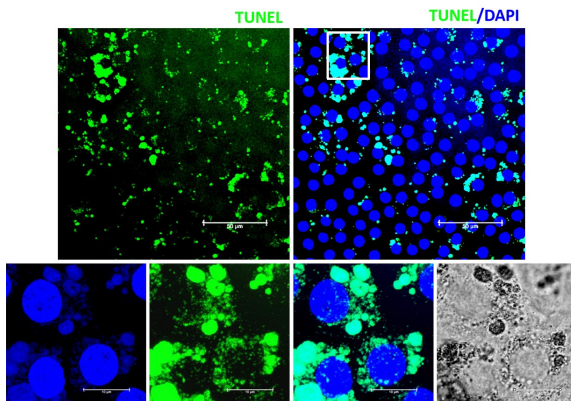

Figure 2: Representative confocal microscopic images of anterior lens epithelium from a cataractous donor eye, immunostained for apoptotic marker TUNEL: The expression of TUNEL was observed in the nucleus of a subpopulation of cells in the central zone cells. Nuclear blebbing was observed in these TUNEL positive cells. The cells in the other zones were negative for TUNEL.

Neural retinal induction of human lens epithelium in vitro:

Regenerative potential of human anterior lens epithelium was evaluated in vitro. The whole lens was cultured with and without neural retina in the supplementation of FGF (Figure 3). In the lens cultured without neural retina, FGF induced the proliferation of the epithelial cells in the equatorial

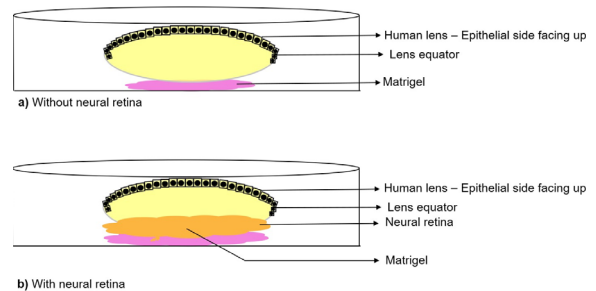

Figure 3: Diagrammatic representation of the whole lens culture system a) without neural retina and b) with neural retina.

zone, the proliferated cells migrated and encircled the posterior capsule (Figure 4). In contrast, in the lens cultured with neural retina, the epithelial cells were induced to differentiate into lens fibres at the equatorial zone (Figure 4).

Analysis of the immunostained cultured lens paraffin sections (Figure 4) revealed the expression of proliferating cell marker Ki-67, to be positive in 60% cells in the central region when cultured without neural retina. In addition, 51% cells that migrated beyond the equatorial zone were also positive. But no such proliferating epithelial cells were observed beyond the equatorial zone when cultured with neural retina (Figure 4). Further, 57.7% of the total lens epithelial cells expressed Ki67 including 62% cells in the central zone.

Conclusion

The expression of stem cell marker SOX-2 in the nucleus was negative in the cataractous lens epithelium. Nuclear bleb formation observed in the central zone was associated with TUNEL positivity, confirming the apoptosis of the cells during cataract.

As demonstrated in mouse lens, in the absence of neural retina, the human lens epithelial cells divided and encircled the posterior capsule. In

S.No		Lens cultured without neural retina		Lens cultured with neural retina	
		Hematoxylin and Eosin staining	Ki-67 Immunostaining	Hematoxylin and Eosin staining	Ki-67 Immunostaining
	Whole lens culture system				
1	Anterior lens epithelium				
2	Equatorial zone				
3	Posterior capsule				

Figure 4: Comparative analysis of human lens cultured with and without neural retina in the presence of FGF. Magnified images of three regions are given - 1. anterior lens epithelium, 2. equatorial zone, 3. posterior capsule. The cultured whole lens sections revealed the proliferation and migration of the epithelial cells beyond the equatorial zone in the absence of neural retina. But when cultured with neural retina the epithelial cells started to differentiate into lens fibers at the equatorial region (arrow indicates differentiated lens fibers). Confocal microscopic images of Ki-67 immunostained lens sections revealed the presence proliferating cells in all the regions (FITC-green+DAPI-blue=cyan blue). The newly formed fibres in the cultured lens with neural retinal induction were also positive for Ki67.

contrast, the lens cultured with neural retina induced fibre differentiation at the equatorial zone.

Further studies are essential to elucidate the ability of stem cells in the human anterior lens epithelium to develop a complete lens with neural retinal induction.

Identification, characterization and maintenance of stem cells in adult human Retinal Pigment Epithelium

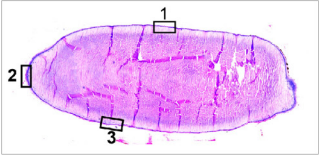
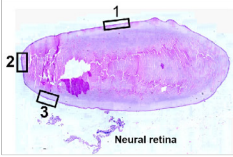
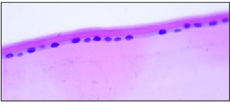
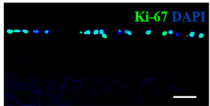
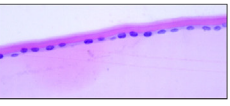
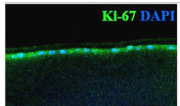
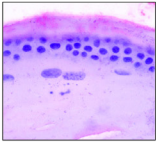
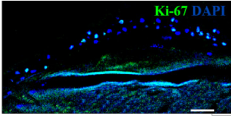
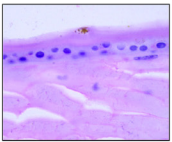
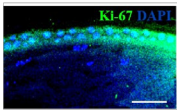
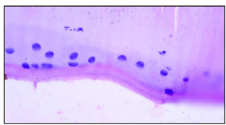
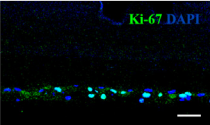
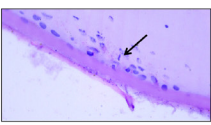
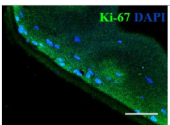
Investigators : Dr. Gowri Priya

Chidambaranathan

Co-Investigators : Prof. VR. Muthukkaruppan

Dr. K. Naresh Babu

Dr. R. Kim

Research Scholar : A. Waseema

Introduction including Background

Retinal Pigment Epithelium (RPE), beneath the neural retina, is a pigmented post-mitotic monolayer of cells actively involved in the replenishment of photoreceptor outer segments. Dysfunction of RPE leads to degeneration of photoreceptors resulting in blindness. RPE stem cells (RPESCs) have been identified only upon culturing. But the location of

these stem cells in native human RPE and their basic biology remains elusive. A higher expression of embryonic stem cell marker OCT4 in the peripheral RPE compared to central and equatorial RPE was demonstrated in this laboratory by real time PCR. Further, upon culturing, both central and peripheral RPE cells were observed to express stem cell markers KLF4 and ABCG2. In continuation, immunostaining of RPE and functional assays were carried out to confirm the location of RPESCs.

Results

Proliferating cells in human RPE

In order to analyse whether proliferating cells are present in adult human RPE, immunostaining of RPE flatmounts (n=3 donor excised globes) for Ki67, a proliferating cell marker was carried out. RPE was demarcated into three regions (i.e) central, equatorial and peripheral regions (three equidistant concentric circles centered on the optic nerve head, Figure 1) and ten fields per region were acquired using confocal microscope for analysis. Proliferating cells were detected only in the peripheral region of RPE (Figure 2) accounting for $0.145 \pm 0.003\%$ of peripheral cells in flatmounts.

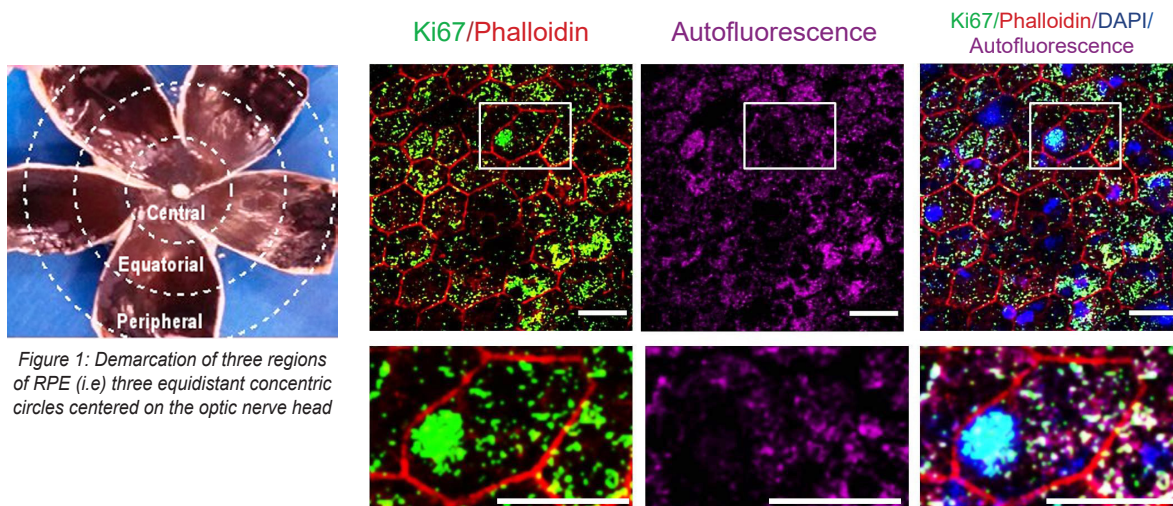

Figure 1: Demarcation of three regions of RPE (i.e) three equidistant concentric circles centered on the optic nerve head

Figure 2: Representative confocal image of human RPE flatmount (72 years, peripheral region) immunostained for Ki67. The enlarged image of Ki67 positive cell is given below (n=3). Scale bar represents 25 μ m.

Sphere forming ability of human RPE

Sphere formation analysis is a functional assay to identify self renewing adult stem cells. To identify the region of RPE encompassing the sphere forming cells, RPE cells isolated from three regions (n=3, Figure 1) by brushing were trypsinised and plated in ultra-low attachment 6 well plates (1000 cells/well) for sphere formation. Sphere forming ability was defined by the percentage of RPE cells capable of forming free floating neurospheres greater than 40 μ m in diameter after 10 days of culture. Spheres were imaged using an inverted phase contrast microscope and ImageJ was used to determine the diameter of the spheres.

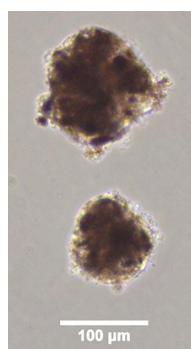

Figure 3: Representative inverted phase contrast microscopic image of human RPE spheres. Spheres were highly pigmented and greater than 40 μ m in diameter.

Only the peripheral RPE cells formed spheres, with the sphere forming ability of $2.25 \pm 0.18\%$. Spheres varied in size - 44.67% between 40 - 80 μ m in diameter and 55.33% greater than 80 μ m in diameter. All cells in the spheres expressed RPE65 indicating their RPE origin and cells in the periphery of the spheres expressed Ki67, the proliferating cell marker confirming that the spheres were formed by proliferation of a cell and not just aggregation. The expression of stem cell markers KLF4, c-MYC and SSEA4 was observed in greater than 50% of cells in the spheres.

Label retaining cell analysis

In order to identify the slow cycling stem cells, RPE cells isolated from three regions (1×10^5 cells /

well) were subjected to adherent culture condition in 48 well plates. After adherence (~10 days), 10 μ M BrdU was supplemented in the culture media for 2 days. Immunostaining with anti-BrdU was carried out after the 2 days of pulse labelling or after 16 days of culture without BrdU to identify the LRCs. Cytosmears were also immunostained for the expression of stem cell markers KLF4 and c-MYC. One hundred consecutive cells were acquired using confocal microscope and the percentage of LRCs were calculated. The peripheral RPE cells encompassed

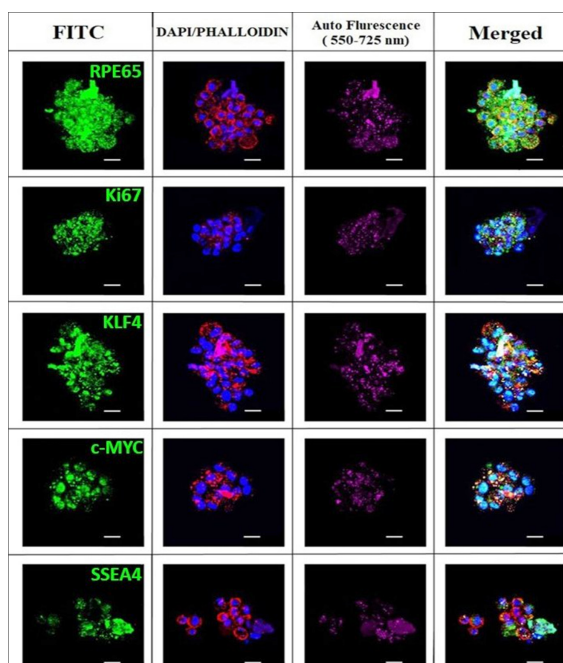

Figure 4: Representative confocal images of RPE spheres immunostained for RPE65, Ki67, KLF4, c-MYC and SSEA4 (green), stained for phalloidin (red) with DAPI (blue) as nuclear counterstain. Scale bar represents 25 μ m.

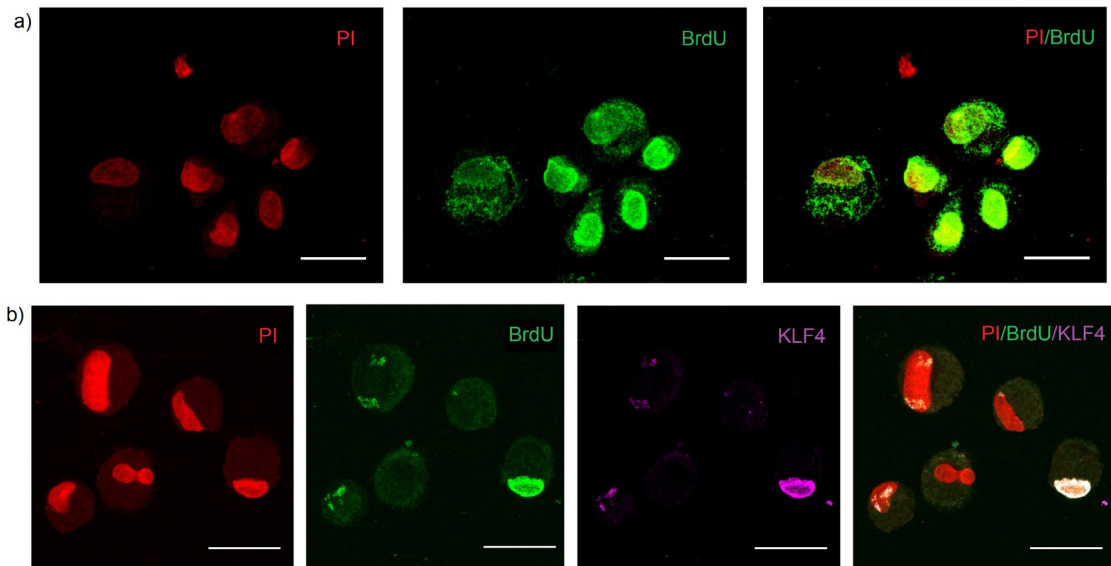

Figure 5. Representative confocal microscopic image of (a) RPE cells pulse labeled with BrdU and (b) label retaining RPE cells, positive for stem cell marker, KLF4. Scale bar represents 25 μ m.

higher percentage of LRCs ($11.33 \pm 5.53\%$) than the equatorial ($3 \pm 2.59\%$) and central RPE (0%) cells. Such LRCs also expressed the stem cell markers KLF4 and c-MYC indicating their stemness.

Conclusion

The presence of cells with proliferation potential, sphere forming ability and higher label retaining property observed in the peripheral region of native human RPE signify the location of adult stem cells in this region of human RPE. Studies are being carried out to understand the status of RPESCs with ageing and in retinal degenerative diseases for the development of better stem cell based therapy.

miRNAs to reprogram human differentiated corneal epithelial cells towards lineage specific adult stem cells

Investigators : Dr. Gowri Priya
Chidambaranathan
Co-Investigators : Prof. VR. Muthukkaruppan
Dr. N. Venkatesh Prajna
Dr. Bharanidharan Devarajan
Research Scholar : A.Waseema
Funding agency : Sun Pharma

Introduction including Background

Small RNA sequencing identified six miRNAs, hsa-miR-21-5p, hsa-miR-143-3p, hsa-miR-150-5p, hsa-miR-3168, hsa-miR-1910-5p and hsa-miR-10a-5p to be highly expressed in an enriched population

of limbal epithelia stem cells (LESCs) which was validated by qPCR analysis. Among the six miRNAs, locked nucleic acid in-situ hybridization revealed that hsa-miR-150-5p and has-miR-143-3p to be expressed exclusively in clusters of small cells in limbal basal epithelium indicating their association with stem cells (Kalaimani et al., 2020). Preliminary studies from this laboratory revealed that transfection of the cultured limbal epithelial cells with miRNAs - hsa-miR-143-3p/hsa-miR-150-5p mimics increased the stem cell content - based on colony forming efficiency (including the holoclones). Hence this study aims to evaluate the efficacy of human corneal epithelial stem cell specific miRNAs in reprogramming differentiated corneal epithelial cells towards lineage specific stem cells.

Results

Transfection of miR 143-3p and miR 150-5p mimics individually

In order to evaluate whether the increase in the stem cells after transfection was due to reprogramming of differentiated cells, the cells near the explant (includes a small population of stem cells) vs far from the explant (includes differentiated cells) were analysed. Briefly, limbal explants cultures at 70% confluency were transfected either with miR143-3p or miR150-5p using lipofectamine 3000. After 48 hours of transfection, cells near the explant and far from the explant were harvested for two parameter analysis (expression of ABCG2 and N/C ratio) and colony forming assay.

Table 1: Effect of transfection on stem cell content

Technique	miR-143-3p				miR-150-5p				miR-143-3p +150-5p			
	mimic		Scrambled		mimic		scrambled		mimic		scrambled	
	near	far	near	Far	near	far	near	far	near	far	near	far
Two parameter analysis-stem cell content (%)	3±0	0.1±0.3	0	0	3 ± 0	0	0	0	3 ± 0	0.5 ± 7	0	0
Colony forming efficiency (%)	5.4±2.1	2.8±0.9	6.0±2.7	3.4±1.9	4.1± 0.7	3.6±1.9	3.8±1.4	3.6±2.5	5.1±0.4	3.9±1.8	3.8±1.4	3.6±2.5
Holo clones (%)	27.7±15.4	12.8±7.4	13.6±10.4	3.3±2.7	41.5±10.6	15.9±8.3	20.5±11.3	5.5 ± 0	51.4±8.4	24.3±12.4	20.5± 11.3	5.5 ± 0

The mimic transfected cells near the explant had 3% of stem cells by two parameter analysis. While not much difference was observed in the total colony forming efficiency among the mimic and scrambled transfected cells, a significant increase in the percentage of holoclones was observed in the miR-143-3p (27.7 ± 15.4%) and miR-150-5p (41.5 ± 10.6%) mimic transfected cells near the explant compared to scrambled (13.6 ± 10.4%; 20.5 ± 11.3% respectively). In addition, the percentage of holoclones was also higher among the cells far from the explant in the mimic transfected group (miR-143-3p- 12.8 ± 7.4% ; miR-150-5p - 15.9 ± 8.3%) compared to the scrambled transfected group (3.3 ± 2.7%; 5.5 ± 0% respectively).

Transfection of miR 143-3p and miR 150-5p together as a cocktail

Since both the miRNA mimics increased the holoclone formation, it was hypothesized that the transfection of both the mimics combined as

a cocktail could lead to better maintenance of stemness. Although transfection of combined miRNA mimics did not increase the stem cell content further as per two parameter analysis, a significant increase in the holoclone formation was observed with the cocktail transfection in cells from both near and far from the explants. The above results indicate that the increase in stem cells upon miRNA transfection might be due to reprogramming.

Conclusion

The transfection of miRNAs together increased the stemness. RNA sequencing of holoclones derived from the transfected limbal epithelial cells is essential to identify the associated transcription factors and signaling pathways that enhances the maintenance of stemness.

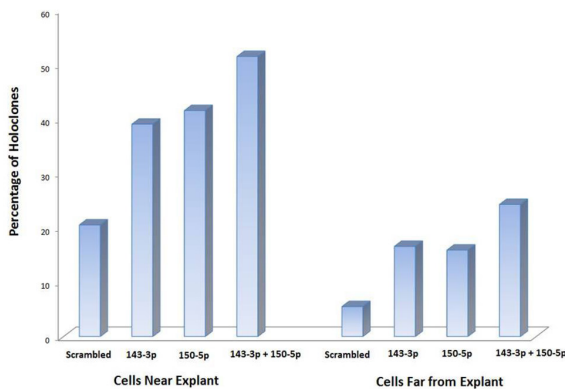

Figure 1: Comparison of the percentage of holoclones obtained from mimic transfected cells

Role of trabecular meshwork stem cell-derived extracellular vesicular miRNAs in human trabecular meshwork regeneration

Investigators : Dr. Gowri Priya
Chidambaranathan
Co-Investigators : Prof. VR. Muthukkaruppan
Dr. S. R. Krishnadas
Research Scholar : R. Iswarya
Funding agency : Sun Pharma

Introduction including Background

Recent reports indicate that transplantation of cultured TM cells in human organ culture glaucomatous (cell loss) model induced TM regeneration through paracrine effect. With increasing evidence in other mesenchymal stem cells, that the paracrine effect is presumably through EVs, this study

aims to elucidate the potential of the TMSC derived EVs in TM regeneration and to evaluate whether the EV-derived miRNAs are responsible for the TM regeneration. In this preliminary study, exosomes were isolated by ultracentrifugation protocol from conditioned media obtained from TM cell culture established from donor eyes and characterized by western blotting for exosomal marker syntenin.

Results

Isolation of exosomes from Conditioned Media

The TM cells were isolated from corneoscleral rims that were not suitable for transplantation by collagenase digestion and cultures were established in TM media. From confluent cultures, the conditioned media was collected and exosomes were isolated by ultracentrifugation. Briefly, conditioned media was preprocessed by differential centrifugation (1500g, 10000 g) to remove cells, debris and filtered through 0.22 μm filter to remove other larger vesicles. The resulting supernatant was underlaid with 2ml of 60% iodixinol solution and centrifuged at 1,63,000g for 92 minutes at 4°C. The final 3 ml medium from the bottom was collected, centrifuged at 1,63,000g for 92 minutes at 4°C and the pellet was suspended in 100 μl of PBS. Samples were stored at -80°C for further characterization.

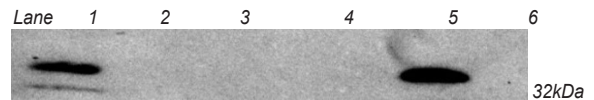

Exosomal characterization by western blotting for syntenin- Lane 1: cultured TM cell lysate (positive control), Lane 2: conditioned medium (CM), Lane 3: supernatant after 1500g centrifugation (to remove dead cells from CM), Lane 4: supernatant after 10000g centrifugation (to remove debris from CM), lane 5: exosomes, lane 6: CM after exosome isolation respectively

Characterization of isolated TM exosomes by western blotting

The isolated TM exosomes with Laemelli buffer were boiled at 100°C for 5 minutes and the protein concentration was estimated by Qubit protein assay kit. To characterize the isolated exosomes, western blotting was carried out. Briefly, the isolated exosomal proteins along with positive control - TM cell lysate were separated by SDS- PAGE, blotted against exosomal marker Syntenin- 32kDa and detection was carried out by chemiluminescent method.

Conclusion

Exosomes were isolated from conditioned medium by ultracentrifugation and the isolated exosomes expressed exosomal marker syntenin. Further studies are essential to characterize the isolated exosomes and to evaluate their efficacy in inducing TM regeneration.

PROTEOMICS

Prediction of treatment outcome in fungal keratitis patients: Validation of tear biomarkers

Investigators : Dr. J. Jeya Maheshwari
Prof. K. Dharmalingam
Clinician Scientists: Dr. NV. Prajna
Dr. Sankalp Sharma
Funding : Cognizant Foundation

Introduction

Fungal keratitis is prevalent in tropical countries such as India with more than 2000 corneal infections reported each year at Aravind Eye Hospital, Madurai. Nearly 40% of these patients do not respond to treatment and require surgical intervention to clear the infection. As there are limited anti-fungal drugs available, methods to predict the outcome of the fungal infection would aid the clinician to identify patients who are unlikely to respond to treatment and suggest an early surgery to these patients. To achieve this, this study examines the potential of five tear proteins and clinical features to predict the treatment outcome in fungal keratitis patients.

Results

In phase 1 of this project, five tear proteins (complement factor H (CFH), complement factor B (CFB), calprotectin (CAL), vimentin (VIM), alpha-2-macroglobulin (A2M), and zinc alpha-2 glycoprotein(ZAG)) were quantified using ELISA in 48 fungal keratitis patients (only *A. flavus* and *Fusarium* infection) and 24 healthy controls.

In phase 2, in addition to *A. flavus* and *Fusarium* infected keratitis patients, tear from patients with other fungal infections such as *Bipolaris*, *Curvularia* were included. Another 28 “no growth” samples were also included. These samples were collected from patients whose corneal ulcer scraping did not exhibit growth upon plating and the source of infection could not be identified by routine microbiological methods. The “no growth” samples constitute nearly 40% of the total fungal keratitis patient samples. Table 1 shows the summary statistics of the clinical features of a total of 136 study subjects, from both phase 1 and phase 2, categorised based on whether they responded to treatment (responders) or not (non-responders).

Further, the levels of five tear proteins were quantified in all the 136 study subjects and the comparison of the levels with reference to the treatment response and infection category is shown in Figure 1.

The box plot compares the distribution of the tear proteins (calprotectin/vimentin ratio, CFH/CFB ratio and alpha-2 macroglobulin) between non-responders and responders across the four patient category.

In Figure 1, the ratio of calprotectin and vimentin as well as CFH and CFB were compared. Calprotectin is an indicator of neutrophil mediated inflammatory response and vimentin is suggestive of wound healing response. The ratio of these two proteins is suggestive of the balance between inflammatory response and wound healing response at the site of infection. The comparison shows that this ratio varies between the infection categories and more

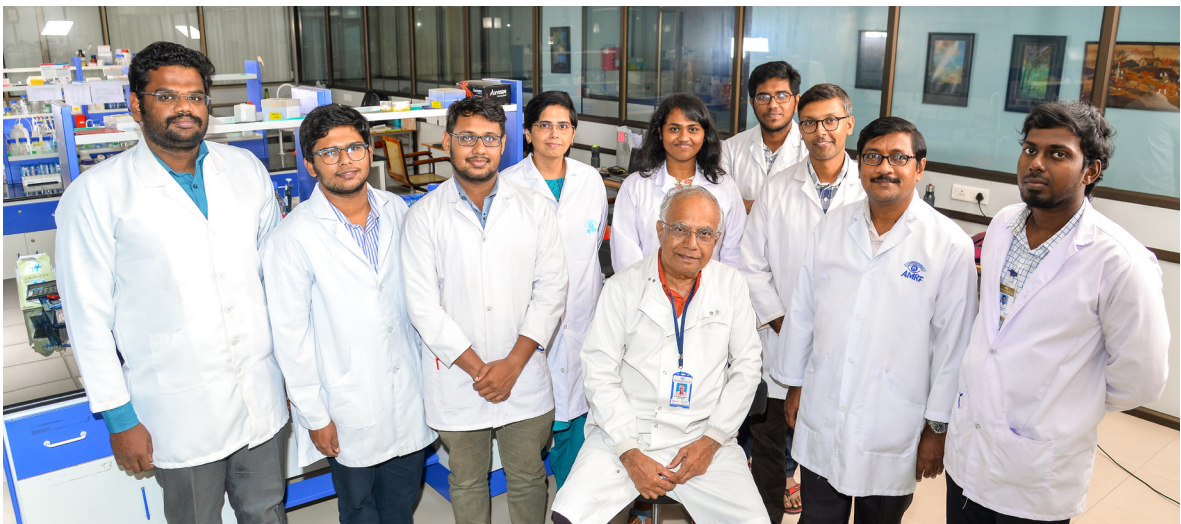

Table 1. Summary of the clinical features of the 136 keratitis study subjects

variable	N	Treatment response			95% CI ^{2,3}	p-value ²
		Overall, N = 136 ¹	Non-responder, N = 52 ¹	Responder, N = 84 ¹		
Category	272				0.72	0.36, 1.1
A. flavus KT	45 (33%)	21 (40%)	24 (29%)			
Fusarium KT	46 (34%)	22 (42%)	24 (29%)			
No Growth KT	25 (18%)	8 (15%)	17 (20%)			
Other Fungus KT	20 (15%)	1 (1.9%)	19 (23%)			
ulcerDuration	272				0.46	0.11, 0.81
<7 days	68 (50%)	19 (37%)	49 (58%)			
7-14 days	33 (24%)	17 (33%)	16 (19%)			
>14 days	35 (26%)	16 (31%)	19 (23%)			
ulcerLocation	272				0.93	0.57, 1.3
Central	75 (55%)	42 (81%)	33 (39%)			
Paracentral	61 (45%)	10 (19%)	51 (61%)			

importantly, non-responders exhibit higher ratio compared to the responders. CFH and CFB are the negative and positive regulators of complement pathways, respectively and their ratio is indicative of whether complement mediated inflammatory response is up or down regulated. Responders seem to have slightly higher CFH/CFB ratio when compared to that of the non-responders.

The ulcer features and tear protein levels were taken for building a logistic regression model to identify the factors that can be useful in predicting the treatment response. For this purpose, the data from 136 keratitis patients were randomly split into training data and testing data in a proportion of 70% and 30%, respectively. Figure 2 shows the Receiver Operating Characteristic curve and AUC for the model that takes into account the ulcer size and location along with the tear A2M, calprotectin and vimentin levels. This model could achieve an AUC of 80% with the training data set. Further, the model was used to predict the treatment outcome in 41 study subjects (test data set) and Table 2 shows the

variable	N	Treatment response			95% CI ^{2,3}	p-value ²
		Overall, N = 136 ¹	Non-responder, N = 52 ¹	Responder, N = 84 ¹		
ulcerDepth	272				1.0	0.67, 1.4
Superficial	52 (38%)	9 (17%)	43 (51%)			
Mid	43 (32%)	14 (27%)	29 (35%)			
Deep	41 (30%)	29 (56%)	12 (14%)			
hypopyon	272				0.68	0.32, 1.0
No	68 (50%)	16 (31%)	52 (62%)			
Not visible	1 (0.7%)	1 (1.9%)	0 (0%)			
Yes	67 (49%)	35 (67%)	32 (38%)			
ulcerSize	272				0.85	0.49, 1.2
<5 mm ²	69 (51%)	14 (27%)	55 (65%)			
5-10 mm ²	63 (46%)	35 (67%)	28 (33%)			
>10 mm ²	4 (2.9%)	3 (5.8%)	1 (1.2%)			

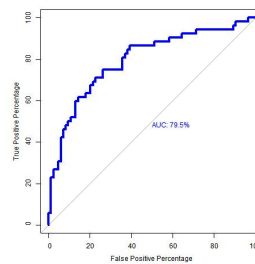

Sensitivity	80%
Specificity (Recall)	88%
Precision	91%
Accuracy	83%
F1 score	85

Figure 2. Summary statistics of the model to predict treatment outcome in fungal keratitis patients

measures of the model fit.

The current model can predict 80% of the non-responders and 88% of the responders correctly with an F1 score of 85.

The current work in progress is to add additional factors such as systemic illness, anti-fungal treatment details and diabetic status to the existing model to examine if the measures of the model fit improves further.

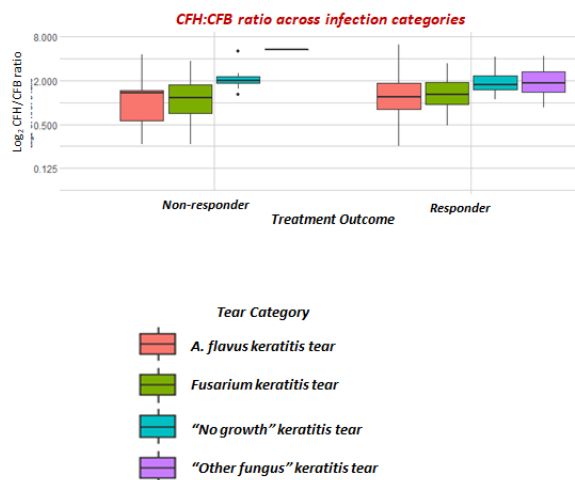
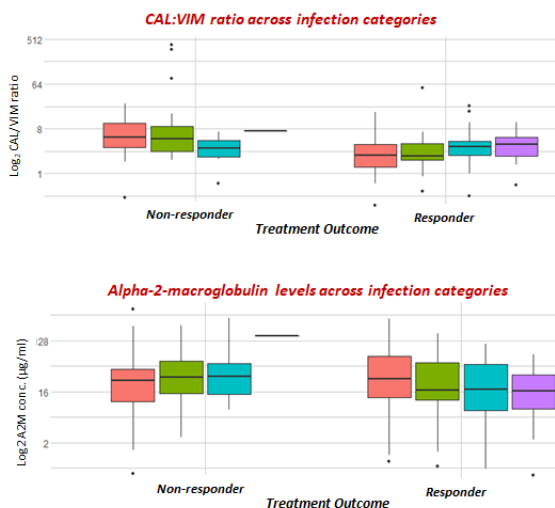

Figure 1. Comparison of the tear protein markers across different categories of keratitis patients.

2. Proteome Profiling of Serum Microparticles in Diabetes and Diabetic Retinopathy Patients: Towards Identification and Validation of Predictive Biomarkers

Investigators : Dr. J. Jeya Maheshwari
Prof. K. Dharmalingam
Clinician Scientists: Dr. R. Kim
Team Member : Subash. KK.
Funding : Department of Health Research,
Govt. of India

Introduction

Diabetic retinopathy (DR), a microvascular complication of the retina, could lead to visual impairment and blindness and nearly, one-third of the diabetic individuals develop this condition. Early detection and effective management of DR is the focus of many research groups working across the globe. Towards this, circulating serum/plasma proteins have been examined extensively for their potential to be used as predictive or diagnostic biomarkers. In this study, the proteins in the serum microparticle proteins were considered as a source of biomarkers. Our previous studies showed significant changes in the proteome of serum microparticles as DR progresses. Based on this analysis, seven proteins that showed significant changes at different stages of DR were chosen for validation in a large sample cohort.

Results

Previously CD41-61, fibronectin and alpha-2-macroglobulin were quantified in a sample cohort of 224 patients. Using the same cohort, peroxiredoxin 2, vitronectin, thrombospondin and vonWillibrand factor (vWF) were assayed using ELISA. Although

differences in thrombospondin and vWF were observed in mass spectrometry data, the sensitivity of the ELISA kits used for quantitation were not sufficient to quantify these two proteins in the serum microparticles. On the other hand, peroxiredoxin and vitronectin were quantified across different control and DR groups and the comparison is shown in Figure 3.

Based on the comparison shown in Figure 3, changes in peroxiredoxin levels is significant only between the non-diabetic control and PDR. No statistically significant changes were observed in the levels of vitronectin across any sample categories.

Amongst all the markers quantified, CD41-61 showed significant changes in the levels with DR progression. CD41/CD61 is the major integrin on platelets and is important for platelet adhesion and aggregation. The ligands for CD41/CD61 include fibrinogen, Von Willebrand factor, fibronectin, vitronectin, and thrombospondin. Since, CD41-61 levels were significantly altered in microparticles in DR, two ligands for this protein – fibronectin and thrombospondin were quantified in serum. Figure 4 shows the comparison of these two protein levels in serum across different patient categories.

Significant alterations were observed in the changes in the level of fibronectin and to a lesser extent in thrombospondin. In both cases, the levels were lower in the later stages of DR (NPDR-moderate, NPDR-severe and PDR) when compared to the control groups (NDM and DM) or early stage DR (NPDR mild).

The levels of the proteins quantified in microparticles will further be correlated to the clinical features of the study subjects to understand biological relevance of the changes in these proteins with reference to DR progression.

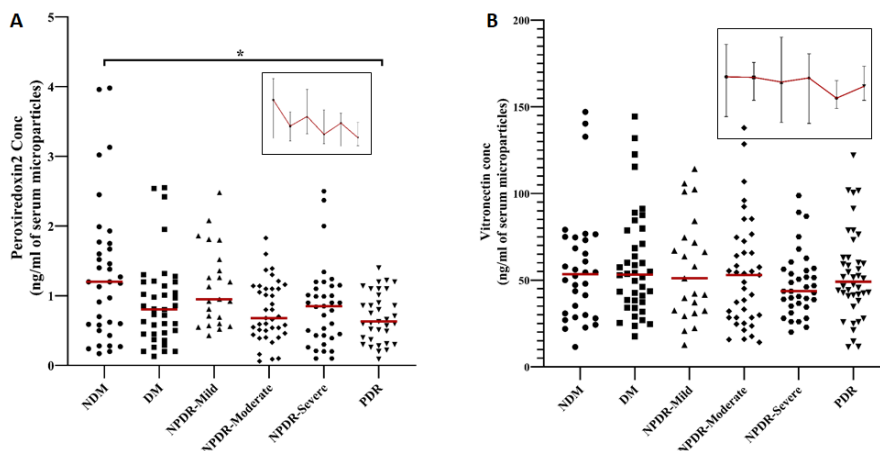

Figure 3. Comparison of peroxiredoxin (A) and vitronectin (B) protein levels in serum microparticles across different sample categories. The inset shows the interval plot with 95% CI showing the trend in the change in the marker levels. NDM, non-diabetic control; DM, type 2 diabetic individuals; NPDR, non-proliferative diabetic retinopathy; PDR, proliferative diabetic retinopathy. * indicates a significant P-value in the range of 0.01 to 0.05.

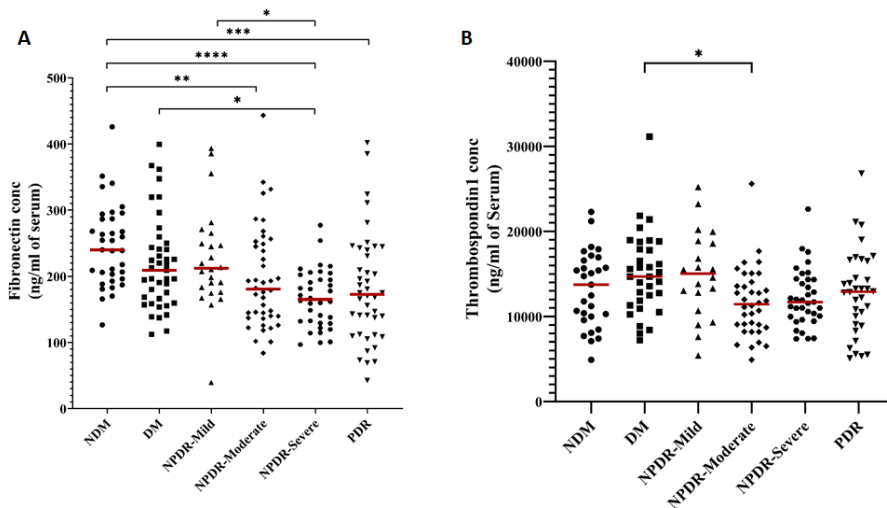

Figure 4. Fibronectin (A) and thrombospondin (B) levels in serum across different sample categories. P-value - * (significant) 0.01 to 0.05, ** (very significant) 0.001 to 0.01, *** (extremely significant) 0.0001 to 0.001, **** (extremely significant) <0.0001

3. Extracellular vesicles in the modulation of host immune response in fungal keratitis patients: Characterization of tear extracellular vesicles

Investigators : Dr. J. Jeya Maheshwari
 Prof. K. Dharmalingam
 Clinician Scientists: Dr. NV. Prajna
 Dr. Poonam
 Team member : Subash. KK
 Funding : Sun Pharma

Introduction

A large number of factors contribute to the pathogenesis of the disease, both fungal and host factors. Amongst these, the communication between the fungus and the host cells during the infection is an important one. In addition to the direct interaction between the host and the fungus, extracellular vesicles (EVs) are essential mediators of intra- and inter-species communication. Although EVs have been reported in tear fluid, their role in fungal keratitis remains unexplored. Hence, the primary objective of this project is to understand the immunomodulatory function of tear EVs in fungal keratitis patients.

Results

Based on prior literature available for the isolation of microparticles and exosomes from serum and other biological fluids, the method for isolating EVs from tear was optimized. Microparticle (MPs) were isolated by centrifugation at 30,000 x g while the resulting supernatant was centrifuged at 1,20,000 x g to pellet the exosomes. The protein yield was consistently obtained at around 4-6 µg for the MPs and 20-22 µg for the exosomes. Based on the NTA analysis (Particle Metrix), particles ranging in size from 17 nm to 748 nm were observed in both the MP

and exosome fractions with an X50 at around 200 nm (Figure 5).

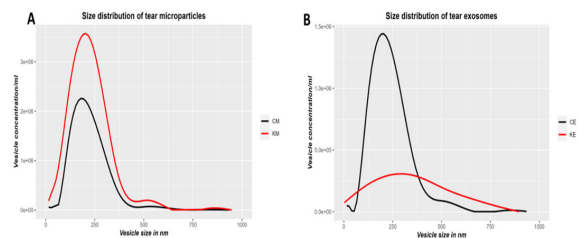

Figure 5: Size distribution and concentration of EVs isolated from control and keratitis tear.

The concentration of EVs in tear (both MPs and exosomes together) was found to be approximately $2.06 \times 10^8 \pm 0.5 \times 10^8$ particles per ml of tear.

The enrichment of EVs were further confirmed using EV specific markers. Microparticles and exosomes were positive for two EV markers - CD9 and TSG101 (Figure 6).

After confirmation by NTA and western blot, the EV samples were analysed for the protein cargo using a bottom-up proteomics approach. A pool of 20 tear samples were used to isolate microparticles and exosomes. Tear EVs from both control

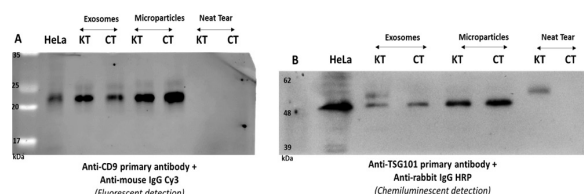

Figure 6. Immunoblot analysis of tear EVs for CD9 and TSG101. Microparticle and exosome proteins were resolved and transferred to a NC membrane. The blot was probed for CD9 (A) and TSG101 (B). HeLa cell lysate was used as a positive control for both markers and neat tear was also included for comparison. CT, control tear; KT, keratitis tear

individuals and keratitis patients were subjected to mass spectrometry analysis that resulted in the identification of 511 and 675 proteins, respectively (Figure 7A). Upon comparison with the proteins reported in Vesiclepedia, it was evident that majority of the tear EV proteins were reported in EVs from three cell types, namely epithelial cell, neutrophils and dendritic cells (Figure 7B).

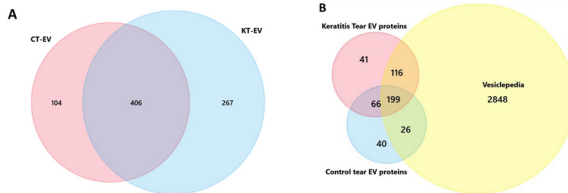

Figure 7. Comparison of the proteins identified in tear EVs. A, comparison of the proteins identified in control and keratitis tear. B, Comparison of the tear EV proteins with that reported in Vesiclepedia database

To understand the functional relevance of EV proteins, an enrichment analysis was done to identify enriched biological process. Table 2 shows the major enriched categories of proteins that together constitute up to 86% of the total EV proteins identified.

The top most enriched category for the tear EV proteins is signal transduction and communication, which is in line with the established role of EVs as a means of communication. Further analysis will be carried out to examine the differences between control tear EVs and keratitis patient tear EVs with reference to each of the enriched categories.

Table 2: Enrichment of tear EV proteins based on GO: biological process

	Control tear EVs	Keratitis tear EVs
Signal transduction/communication	25%	23%
Protein metabolism	16%	17%
Metabolism	15%	12%
Energy pathways	14%	12%
Cell growth and/or maintenance	9%	11%
Immune response	7%	11%
Transport	10%	9%
Regulation of nucleobase, nucleoside, nucleotide and nucleic acid metabolism	5%	6%

Also, the immunomodulatory role of tear derived EVs will be examined using *in vitro* cell systems (macrophage and neutrophils) as well as using *in vivo* infection models (*Galleria* or *C. elegans*).

Understanding the mechanism of action of a novel chemical cross-linker designed to treat keratoconus

Investigators : Dr.O.G.Ramprasad,
Prof. K. Dharmalingam,
Dr. Venkatesh Prajna and
Dr. Naveen Radhakrishnan

Research fellow : Sumaiya Sirajudeen

Clinical fellow : Dr. Seema Yadav

Funding : ICMR

Introduction including background

Keratoconus is one of the major corneal ectasias affecting the young population in their second and third decades of life. Due to the decrease in the mechanical strength of the collagen fibrils in the cornea and significant loss of extracellular matrix, keratoconus is characterized by the thinning of the cornea followed by the formation of cone shaped central cornea. In addition to that, decreased collagen cross-linking activity leads to keratoconus. Consequently, defective vision in the form of severe astigmatism develops. The severity of the disease is classified on the basis of radius of curvature of anterior segment of the cornea.

Our collaborators at the University of Liverpool, UK have developed a novel, PBS soluble chemical cross-linker, consisting of EDCI/NHS [1-Ethyl-3-(3-dimethylaminopropyl)carbodiimide/N-hydroxysuccinimide] mediated chemistry and a suberic acid spacer that has the potential to be developed as eye drops. It can cause corneal cross-linking without removing the corneal epithelium, or the use of UV-A irradiation, therefore avoiding the pain associated with the conventional crosslinking treatment of keratoconus and the risk of infection. We, at Aravind Medical Research Foundation and Aurolab have established the proof-of concept in human corneas, wherein treatment of the diseased keratoconus cornea for 15 minutes at 37°C with the novel chemical cross-linker is able to increase the stiffness of the weak keratoconus cornea by cross-linking collagen molecules. The cross-linker also does not cause cytotoxicity or morphological changes to the corneal cell layers. The details about the investigation are available in the previous progress reports as well as in the publication (Haneef et al., 2021). The mechanism of action of the cross-linker

in stiffening the cornea is not clearly understood. By unravelling the mechanism of action of the novel chemical cross-linker solution, this present study will aid in the further development and / or refinement of optimal formulation of the cross-linker for further pre-clinical trials.

Results

Keratoconus is now characterized as an inflammatory disorder. As a first step to identify the mechanism of action of the cross-linker, we analysed the effect of cross-linker on the regulation of select transcripts in human corneal epithelial cell line (HCE) and in stromal cells. The difference in the arrangement of epithelial cells in the corneal epithelium and the stromal cells in the corneal stroma necessitated the analysis of differential gene expression in cells derived from these layers. A previous study in the corneal epithelium displayed differential expression of a distinct set of inflammatory cytokines in keratoconus (Pahuja et al., 2016). In our study reported here, we analysed the effect of cross-linker on the gene expression of inflammatory cytokines IL-6, MMP-9, MMP-2, Col1A1 in HCE cells and compared their expression in stromal cells. We also estimated the secreted matrix-metallo proteases (MMPs) from these cells and the influence of cross-linker on the activity of these enzymes.

Changes in the expression of transcripts and the effect of cross-linker

HCE cells were treated with 10 ng/ml TNF- α to induce inflammation encountered in keratoconus and the induction of inflammatory cytokines IL-6, MMP-9 and the matrix gene Col1A1 were assessed

by PCR. RNA from the control and treated cells was isolated at 6 hr time-point and reverse transcribed for PCR. GAPDH was used as an internal control for normalization of gene expression. IL-6 and MMP-9 expression increased more than two-folds with 10ng/ml TNF- α treatment, while the Col1A1 expression decreased Fig. 1A).

The concentration of cross-linker required for treatment of the HCE and stromal cells derived from keratoconus cornea was optimized. Accordingly, after treatment with the cross-linker (1/64 dilution), the expression of IL-6 went up by more than 1.5-folds while the expression of Col1A1 decreased further when compared to the TNF- α induction (Fig. 1A and C). Upon cross-linker treatment, there was only a slight decrease in the expression of MMP-9 compared to the TNF- α treatment. Similar changes in gene expression were achieved by real-time PCR analysis before and after cross-linker treatment (Fig. 1C).

With regard to stromal cells, there was a reduction in the gene expression of IL-6, MMP-2 and Col1A1 after cross-linker treatment (Figs. 1B and D). Expression of MMP-9 was negligible in stromal cells and expression of MMP-2 was negligible in epithelial cells which were in tune with the earlier reports. The cross-linker could thus reduce the expression of inflammatory cytokines in stromal cells derived from keratoconus cornea.

Analysis of secreted MMPs from epithelial and stromal cells and the effect of cross-linker

The role of MMPs in the regulation of extracellular matrix and basement proteins has been elucidated well and many MMPs have known to be affected in Keratoconus (di Martino et al., 2019). MMPs are secreted proteins and we have estimated the levels of secreted MMPs-1, 2 and 9 in the conditioned medium of corneal epithelial cells (HCE) and keratoconus stromal cells before and after cross-linker treatment by ELISA. MMP-1 is a collagenase and MMPs 2 and 9 are gelatinases.

Secreted MMP-9 expression increased more than 2-folds after induction of inflammation in HCE cells but the expression came down drastically after cross-linker treatment (Fig. 2A). Secreted MMP-9 was not detected in stromal cells. Secreted MMP-2 expression was very high in stromal cells but very low in HCE cells, and in both the cases the expression came down drastically

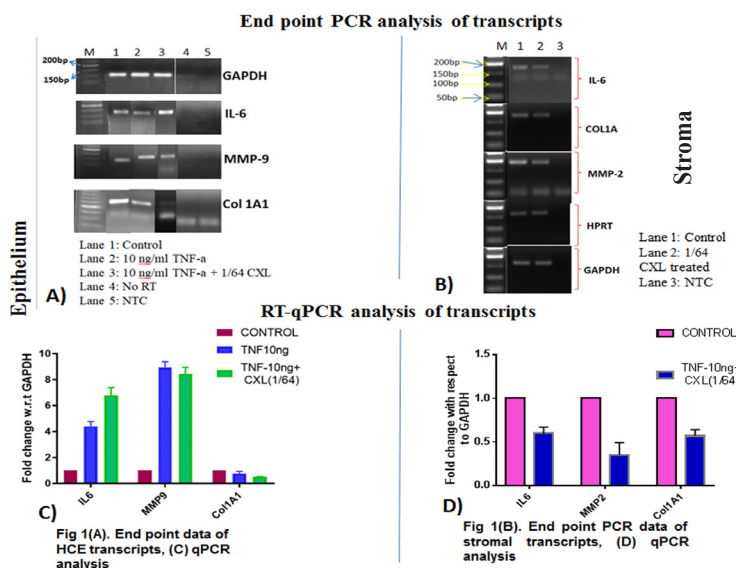

Figure 1: Analysis of transcripts in HCE and stromal cells by PCR

after cross-linker treatment (Figs. 2B and C). Secreted MMP-1 expression was also reduced in HCE and stromal cells after cross-linker treatment (Figs. 2D and E). These observations make it clear that the cross-linker reduces the secretion of the MMPs-1, 2 and 9 and thereby prevent the degradation of matrix proteins.

Effect of cross-linker on the activity of matrix metalloproteases

We performed gelatin zymography assays to assess the effect of the cross-linker on the activity of secreted MMP-s 2 and 9, which are gelatinases. The conditioned media containing the secreted MMPs from the epithelial and stromal cells before and after cross-linker treatment were used for analysing the gelatin digesting activity of the MMPs. The gelatin containing native PAGE gels exhibit white bands at the molecular weight positions of different MMPs indicating the digestion of gelatin. The strength of the gelatinase activity depends on the thickness of the bands.

In the untreated HCE cell medium, the activity of MMPs 2 and 9 were very weak, but increased upon TNF- α treatment due to the increase in inflammatory

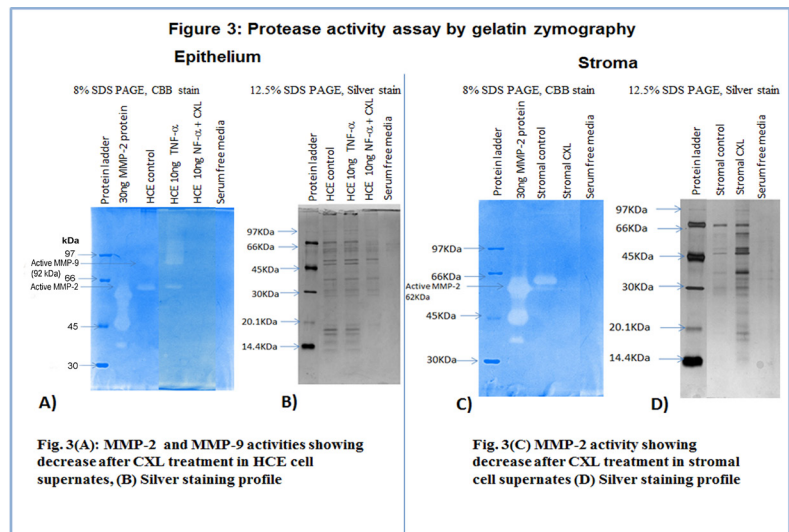

Fig 3 : Protease activity assay by gelatin zymography

signals. Cross-linker nullified the activity of these MMPs (Fig. 3A). This was inspite of other proteins getting secreted in the conditioned medium after cross-linker treatment (Fig. 3B). A similar pattern in the decrease of activity of MMP-2 was observed in stromal cells after cross-linker treatment (Figs. 3C and D). There was no activity of MMP-9 visible in stromal cells which were in tune with nil expression of MMP-9 analysed by ELISA.

Taken together, the above results indicate that the cross-linker decreases the expression and activity of MMPs-1, 2 and 9, thereby decreasing the degradation of different collagen molecules.

Figure 2: Analysis of secreted MMPs in HCE and stromal cells

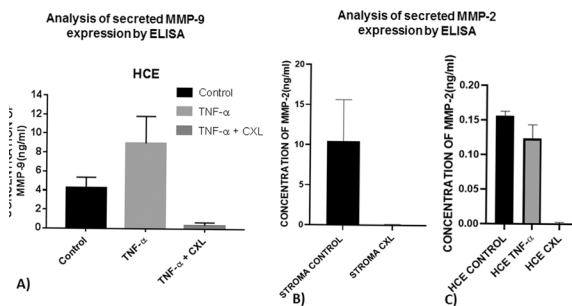
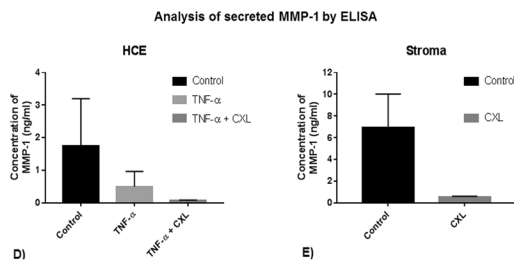

Fig 2(A). ELISA data showing decrease in MMP-9 levels after treatment with CXL

Fig.2(B) ELISA data showing decrease in MMP-2 levels after treatment with CXL in stroma, and (C) in HCE supernates



Quantification of MMP-1 expression by ELISA in HCE cell supernates, Fig. 2(D), and in keratoconus stromal cell supernates, Fig. 2(E). CXL represents cross-linker treatment.

Figure 2: Analysis of secreted MMPs in HCE and stromal cells

Conclusions

The novel cross-linker could reduce the gene expression of MMP-9 and Col1A1 in corneal epithelial cells and expression of MMP-2, IL-6 and Col1A1 in stromal cells. The expression of these genes are reported to be upregulated in keratoconus and the cross-linker could reduce the inflammatory conditions associated with keratoconus. MMP-2 and 9 analysis by gelatin zymography and ELISA showed consistent decrease of MMP-2 and MMP-9 after crosslinker treatment, in both epithelium and stromal cell secreted supernates. The CXL possibly inhibits the surge in activity of MMP-2 and MMP-9, which are actively involved in keratoconus. The novel chemical crosslinker seems to be associated with the signalling pathways involving the MMP-2 and MMP-9, leading to corneal stiffening, thereby halting the progression of keratoconus disease. Further whole transcriptome analysis and proteomic analysis in keratoconus corneas after cross-linker treatment will confirm the involvement of these molecules and their associated signalling pathways in the cross-linker associated stiffening of the cornea.

Screening the Kadaladi family with early onset Glaucoma for Myocilin and other gene mutations

Investigators : Prof. K. Dharmalingam
Dr. S.R. Krishnadas,
Dr. Mohideen Abdul Khadar,
Dr. P. Sundaresan,
Dr. D. Bharanidharan
Technician : V. Saravanan
Funding : Sun Pharma

Background

The myocilin (MYOC) gene is the first and most extensively investigated gene associated with familial forms of POAG (Wang et al 2019). MYOC consists of three exons, which encode 55 to 57 kDa myocilin protein of 504 amino acids. MYOC variants are associated with 2% to 4% of adult-onset POAG (18), and 10% of JOAG (Wang et al 2019). Patients with Myocilin variant report with very high IOP (Johnson et al., 1993; Wiggs et al., 1998) at presentation. Unlike adult-onset POAG, JOAG patients with myocilin variants were reported to have high intraocular pressure (IOP) at early-onset (usually <40 years) with severe optic nerve damage, which, if left untreated, results in severe visual impairment (Gupta et al., 2018). Thus, screening of MYOC variants among JOAG patients helps detect the disease early in the family members. In addition, recent studies have shown the efficacy of therapeutic targets specifically among those with Myocilin glaucoma (Jain et al., 2017, Wang et al 2019, Yang et al., 2020).

In this study, we have screened a large family from Kadaladi, Tamil Nadu, for MYOC variants. Based on the initial findings, the disease could be JOAG. In addition, whole-exome sequencing was used to identify the pathogenic variants of other genes in the POAG suspects who did not carry any variants in the MYOC exons.

Results and Conclusions

A MYOC variant N480K (c.1440C>G) was observed in the proband as shown in the Figure 1.1. This variant was also detected in 20 family members, of whom 15 were diagnosed as POAG, two were POAG suspects and three were unaffected. Of the three unaffected, two were 4.5 and 2.1 years old, and one was 25 years old. The earliest to develop the disease was a ten-year-old child. The penetrance of the variant was 95% over ten years of age.

Al though the two POAG suspects (ID: 10 and 23) carried N480K MYOC variant, other three POAG suspects of the family (ID: 6, 14, and 46) did not carry any MYOC disease-causing variant. Despite

this family's homogeneity, using the WES approach, we identified CYP1B1 gene variant L432V in POAG suspects (ID: 6, 14, and 46). Further screening of CYP1B1 gene in the close relatives (IDs: 17, 45, 16 and 7) revealed its inheritance in this family (Figure 1). We consistently found the CYP1B1 variants in all three families when coexisting with the variant in MYOC exons 1 or 2 led to the POAG suspect condition. Moreover, similar analysis under ten years of family members identified a child (ID44) with L432V CYP1B1 variant and MYOC polymorphism (R76K), suggesting that child may develop similar phenotype. However, the development of full POAG in those POAG suspects is yet to be determined.

These results confirm and extend the observations of a previous study (Bhattacharjee et al., 2008). They also observed that L432V generates oxidative stress resulting from higher ROS (reactive oxygen species) in retinal pigment epithelial cells and might lead to apoptotic changes causing retinal ganglion cell loss and glaucoma. R368H has been observed as a predominant variant in Indian JOAG and POAG patients (Acharya et al., 2006, Gupta et al., 2018, Kaur et al., 2018). We also found this variant in addition to L432V in three family members with MYOC variants in exons 1 and 2. Biochemical data and the data presented in this study and published previously (Vincent et al., 2002, Acharya et al., 2006, Bhattacharjee et al., 2008, Gupta et al., 2018, Kaur et al., 2018) strongly indicate the pathogenic potential of the CYP1B1 variant, particularly in a patient carrying common variants in the myocilin gene.

In conclusion, this study reveals that MYOC variant is primarily responsible for early and late-onset POAG in the Kadaladi family, emphasizing the importance of screening for this variant at a younger age for early treatment. Besides, CYP1B1 gene variants in this family may play a role in the disease onset and progression, requiring further examinations.

Determination of ocular microbiome profile of keratitis patients using a metagenomics approach.

Investigators : Prof. K. Dharmalingam,
Dr. J. Jeya Maheshwari,
Dr. D. Bharanidharan, Dr. Lalitha
Prajna, Dr. N. Venkatesh Prajna.
Funding : Cognizant

Introduction

Recent studies using NGS-based methods on conjunctival swabs confirmed the presence of core bacterial microbiota on the ocular surface (Kugadas

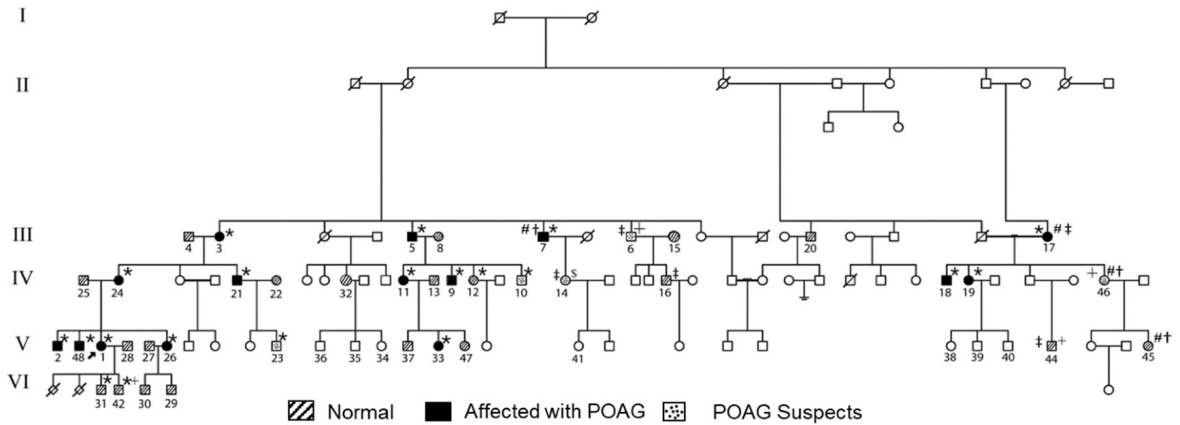

Figure 1.1. The pedigree chart of six generations of a Kalagadi family with glaucoma.

The asterisk (*) symbol indicates a heterozygous MYOC gene variant at c.1440C>G (p.Asn480Lys), (+) symbol indicates c.227G>A (p.R76K) and (\$) symbol indicates c.703T>C (p.Y235H). The single (†) and double (‡) dagger indicate a homozygous and heterozygous CYP1B1 gene variant at c.C1294G (p.L432V). The number sign (#) indicate a heterozygous CYP1B1 gene variant at c. G1103A (p.R368H). The empty boxes and circles are not analyzed for variant analysis. Arrow indicates the proband.

& Gadjeva, 2016; Lu & Liu, 2016). Studies have examined the alteration in the bacterial community (Ge, Wei, Yang, Cheng, & Huang, 2019) and whether the antibiotic treatment (Tanure, Cohen, Sudesh, Rapuano, & Laibson, 2000) lead to reduction in the resistance of the eyes to fungal infections. Further they have showed that the presence of ocular microbiota strengthens the ocular immunity by increasing various immune effector molecules. Therefore, it has been demonstrated in the animal-models that colonization of bacterial commensal on the ocular surface has protective role against the pathogen infection (Kugadas and Gadjeva 2016; St. Leger et al. 2017; De Paiva et al. 2016). Interestingly, dysbiosis of ocular surface microbiome has been reported widely in several ocular surface disorders and infectious diseases, including fungal keratitis. Despite the fact that dysbiosis exists in fungal keratitis, how the dysbiosis is altered during keratitis progression and after treatment is not studied. In this

project, we will be examining the bacterial and fungal microbiome in the initiation, progression and outcome of fungal keratitis mainly caused by *Aspergillus flavus* and *Fusarium solani*.

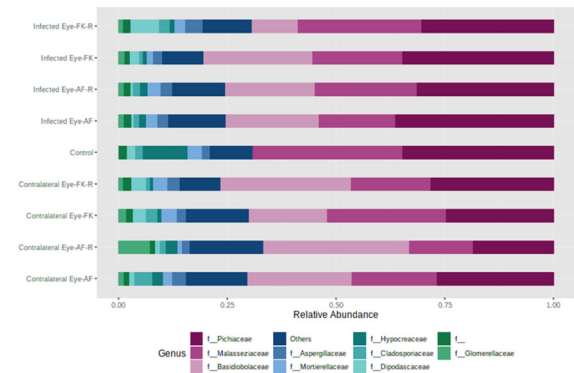
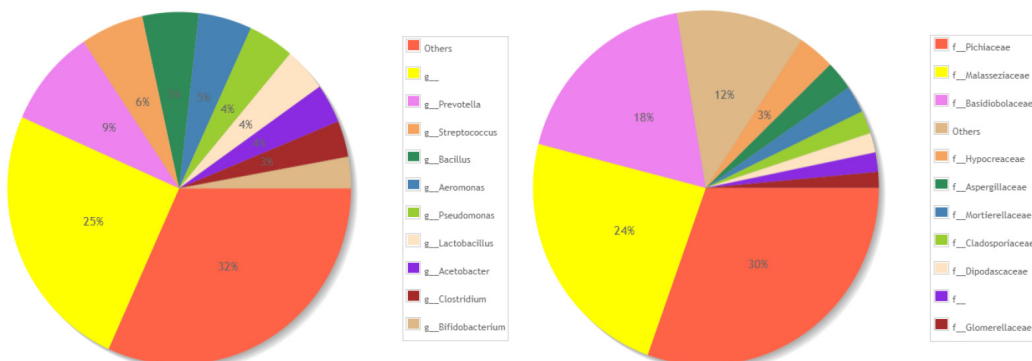

Figure 2.2. Relative Abundance of top 10 fungus from microbiomes of conjunctival swabs of infected and contralateral eye of *Fusarium solani* and *Aspergillus flavus* keratitis patients as well as review cases. Control groups is from cataract patients.

Figure 2.1. Top ten core ocular surface microbiome of bacterial (left) and fungal (right) community.



Results and Conclusions

We collected the conjunctival swabs of both infected and contralateral eyes from fungal keratitis patients. Totally, 25 samples, positive for *A. flavus* (16 samples) and *Fusarium solani* (9), were sequenced for both 16s and ITS metagenomics sequencing. Also conjunctival swabs from ten cataract patients and two airswabs were used as controls. The raw reads obtained from miSeq illumina platform were processed using qimme tool for both 16s and ITS OTU analysis.

The core microbiome analysis was first performed for both bacterial and fungal ocular community. As shown in the figure 2.1, the top 10 genera of both bacterial and fungal community were commonly in the all samples. However, there were variable abundance in each group, expectably in control cataract group (Figure 2.2).

Further analysis of differential abundance in both bacterial and fungal ocular microbiome have showed several bacterial and fungal genus differentially expressed in infected eyes compared to uninfected eyes. Similar differential abundance analysis was performed in review cases, and separately for *Fusarium solani* and *Aspergillus flavus* keratitis patients. As observed earlier, Linear Discriminant Analysis (LDA) Effect Size (LEfSe) analysis on all the groups showed differential abundance of several core microbiome genus, which was affected by control group (Figure 2.3)

The differential abundance analysis on infected and contralateral eyes of the keratitis patients identified more than eight genera of bacterial community and four of fungal community. Of these, *Sutterella* bacteria was found to be putative marker as shown in the Figure 2.4, which showed alter expression after the treatment in both eyes. Thus, the dysbiosis exists in fungal keratitis, which is altered

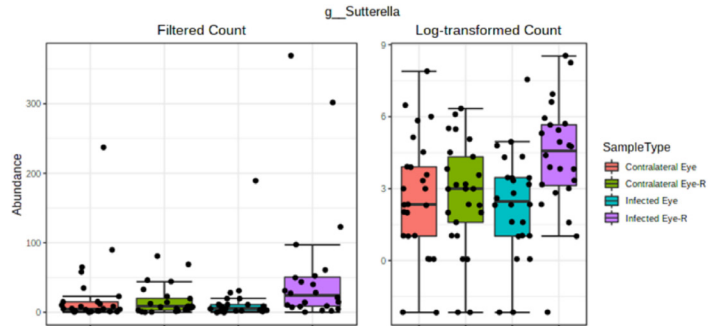

Figure 2.4. The abundance of genera *Sutterella* was differentially observed from microbiomes of conjunctival swabs of infected and contralateral eye of keratitis patients as well as review cases.

during keratitis progression and after treatment. Further analysis is being performed to identify fungal genera that is altered during keratitis progression and after treatment.

Identification of druggable targets for attenuating the progression of pterygium development

Investigators : Dr. Daipayan Banerjee
 Prof. K. Dharmalingam
 Clinician Scientists: Dr. N. Venkatesh Prajna
 Clinician : Dr. Gonugunta Vishnu Teja
 Team Member : Aadithiya T Gr
 Funding : Sun Pharmaceuticals

Background

Pterygium is a benign, chronic triangular overgrowth of fibrovascular conjunctiva growing mostly from the nasal side of the conjunctiva onto the cornea. It is a common condition globally with approximately 13% prevalence in Indian population that increases to about 25% in the elderly. Although benign, this abnormal growth protrudes towards the cornea, impairs vision and ultimately affects the quality of life. This lesion of the ocular surface can be compared to

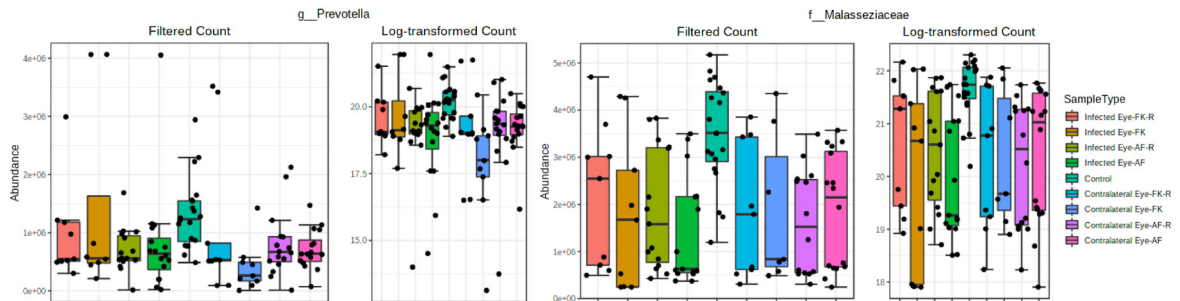

Figure 2.3. The abundance of genera *Prevotella* and *Malasseziaceae* was differentially observed from microbiomes of conjunctival swabs of infected and contralateral eye of *A. flavus* and *F. solani* keratitis patients as well as review cases, and cataract control. Both filtered OTU counts and log transformed count were plotted.

neoplastic-like disorder i.e., cancer as it involves cell proliferation, migration, angiogenesis, fibrosis, and extracellular matrix remodeling. In the absence of any pharmacological intervention, surgical removal of the pterygium outgrowth is the only definite treatment constituting the standard of care. Invasive surgical procedure, cost of surgery and high recurrence rate are deterrent factors that affects patient compliance. Upon confirmation, topical steroids and non-steroidal anti-inflammatory drugs (NSAIDs) are used to reduce inflammation. During surgery, mitomycin C (MMC) has been used as a fibroblast proliferation inhibitor to ameliorate the chance of recurrence of the pterygium. However, serious complications of mitomycin C includes necroptosis resulting in corneal edema, corneal perforation, and scleral calcification. 5-fluorouracil (5-Fu) used an anti-proliferative agent has high chances of recurrence. Anti-VEGF drug Bevacizumab had no significant effect on recurrence of primary pterygium excision. Thus, there is an urgent need to find a druggable target that can preclude the need for surgical intervention in pterygium treatment.

While pterygium has been strongly associated with ultraviolet light exposure and evidence implicates several divergent mechanisms like antiapoptotic factors, immunological, cytokines, growth factors, extracellular matrix (ECM) modulators, genetic factors, viral infection as possible causative, the etiology of this disease is still elusive.

Major Objectives

1. Comparative proteomics of pterygium tissue and the control cataract tissue.
2. Transcriptomics analysis to identify altered mRNA transcripts in pterygium.

Results

1. Profiling of pterygium conjunctiva tissue and tear proteome

With the broad objective to identify pathways that might be activated and contribute to pterygium development and progression, we took a shotgun proteomic approach. Conjunctival tissue samples were collected from patients undergoing pterygium removal surgery. Conjunctival tissue samples from patients undergoing Small Incision Cataract Surgery (SICS) served as control. To understand the milieu that might contribute to the disease pathology, we collected tears from diseased patients and tears from patients with cataract served as control. The number of unique and common proteins identified are represented in Figure 1a. The top biological processes that are either up-regulated or uniquely represented in the pterygium tissue involves

Cataract vs Pterygium: Conjunctiva

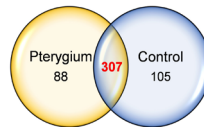

Cataract vs Pterygium: Tear

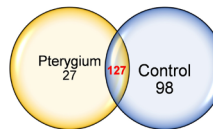

Figure 1a: Number of common and unique proteins identified by MS in conjunctival tissue and tear samples (PSM>=5, Peptide>=2)

Pterygium vs cataract

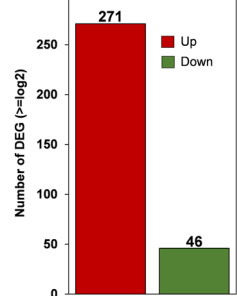

Figure 1b: Number of up-regulated and down-regulated genes by RNASeq (DEG>=logFC 2)

extracellular matrix organization, complement activation, cellular oxidant detoxification/response to reactive oxygen species and immune response. Amongst the top proteins enriched in tears from pterygium patients are Cystatin-SN, Ribonuclease 4 and Angiogenin which are involved in cell proliferation and angiogenesis.

2. Transcriptomics analysis to identify altered mRNA transcripts in pterygium.

RNA-Sequencing analysis was conducted with 8 conjunctival samples from patients with pterygium and were compared to 5 conjunctival samples from patients with cataract. Amongst the 1557 differentially expressed genes (DEGs) identified in pterygium tissue compared to control cataract tissue, 1342 genes were mapped by gProfiler. Pairwise comparison with DEG criterion set as a change $\geq \log_2$ fold has identified 271 up-regulated (20.2%) and 46 down regulated genes (3.4%) (Figure 1b). The biological processes that were enriched in the transcriptomics analysis are cell adhesion,

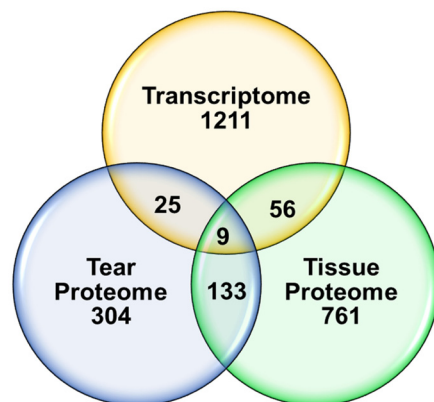

Figure 1c: Venn diagram of common genes in pterygium proteome and transcriptome

extracellular matrix organization, Proteolysis, Inflammatory response and Angiogenesis.

Comparative analysis of the proteomics and transcriptomics data have identified 9 genes in common (Figure 1c). Amongst the 9, the antioxidant protein Glutathione peroxidase and the lipocalin family protein Apolipoprotein D are enriched at pterygium conjunctival tissue transcript level and at protein level in both tear and conjunctival tissue.

Conclusion

By comparative proteomics and transcriptomics approach we have identified several candidate pathways and potential biomarkers that can be targeted by small molecule pharmacological inhibitors to attenuate the progression of pterygium.

Extracellular vesicles in ocular diseases: Towards the development of novel diagnosis and reconfigurable therapeutics -Role of extracellular vesicles in the pathology of neovascular ocular diseases

Investigators : Dr. Daipayan Banerjee
Prof. K. Dharmalingam
Clinician Scientists: Dr. R. Kim
Dr. Naresh Babu
Clinician : Dr. Sagnik Sen
Team Member : Aadithiya T Gr
Funding : Sun Pharmaceuticals

Background

A wide gamut of eye diseases namely diabetic retinopathy, wet age-related macular degeneration (AMD), retinal artery or vein occlusion, retinopathy of prematurity (ROP), neovascular glaucoma, and corneal neovascularization as a result of infectious or inflammatory processes carry a lion's share

for the burden of global blindness. The common processes that interweaves these eye diseases are ocular angiogenesis and inflammation. Pathologic angiogenesis is the development of new blood vessels from pre-existing vasculature in the eye can lead to severe visual impairment.

The retinal cells both under healthy physiological and pathological conditions, communicate with each other or with another one, via cell junctions, adhesion contacts, and secreted soluble factors that can have role in neighbouring or long-distance cells. One such critical conduit for intracellular communication are extracellular vesicles (EV). EVs are lipid membrane bound nano-particles secreted by most, if not all cell types in the extracellular spaces. Extracellular vesicles aid in intercellular communication in diverse cellular processes and modulate biological functions ranging from tissue homeostasis, regulation of inflammation to tumour growth and metastasis. While the role of EVs in angiogenesis is well documented, the dearth of knowledge exists in how EVs contribute to ocular angiogenic diseases.

In this study, we want to focus on two angiogenic ocular diseases: Diabetic Retinopathy (DR) and wet Age-related Macular Degeneration. Diabetic retinopathy (DR), a complication of diabetes is a progressive ocular disease of leaky abnormal retinal blood vessel formation/growth and haemorrhagic blood vessels. Clinically it is divided into two stages: i) non-proliferative DR (NPDR) ii) Proliferative DR (PDR), which causes significant vision loss and is characterized by neovascularization, vitreous haemorrhage, and retinal detachment. Age-related macular degeneration is a multifactorial maculopathy is characterized by neuro-degeneration of photoreceptors and retinal pigment epithelium (RPE) and depending on exudative or non-exudative phenotypes are classified as "wet" (choroidal neovascularization) or "dry" (geographic atrophy)

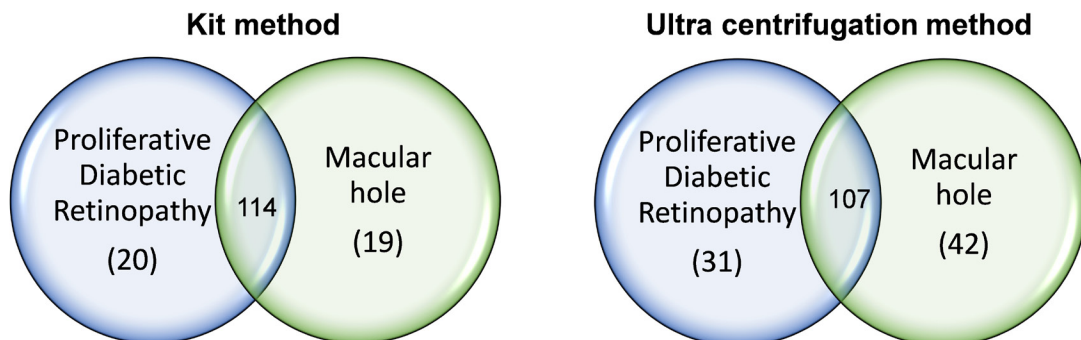

Figure 2: Number of unique and common EV proteins identified by shotgun proteomics in plasma from PDR patients compared to patients with macular hole

AMD respectively. The broad objective of the study is to decipher how EVs alter their cargo content and affect the function of the retinal cells leading to ocular disease.

Major Objectives

1. Test how Extracellular Vesicles (EVs) isolated from patient ocular fluids alter retinal cell functions.
2. Characterize Extracellular Vesicles (EVs) isolated from patient ocular fluids and plasma.
3. Evaluate how stress conditions affect EV content and downstream function of retinal cells.

Preliminary Result

The preliminary work is focused towards optimizing the EV isolation process from the samples that will be used in the study, starting with human vitreous humor and plasma samples. In the process, we are evaluating the role of EVs in the pathogenesis of diabetic retinopathy, first by understanding the differences in EV protein content by mass spectrometry proteomic analysis from patient samples.

1. EV isolation from human vitreous humor and plasma samples are optimized.
2. EVs have been characterized by Transmission electron microscopy (TEM) analysis and Nanoparticle Tracking Analysis (NTA) with Particle Metrix ZetaView®.
3. Shotgun mass spectrometric analysis conducted with EV proteins isolated from plasma of patients with Proliferative Diabetic Retinopathy and control patients with macular hole reveals unique and common proteins isolated by EV isolation kit or ultracentrifugation method (Figure 2).

Conclusion

Using two different methods: 1. Ultracentrifugation 2. Commercially available kit we have optimized isolation of EV from plasma and vitreous humor samples. NTA analysis have revealed that the Median diameter (X50) of the EVs are 162-170nm range and the concentration is of 3-5.0E+9 Particles / mL of biological fluids. Shotgun mass spectrometry analysis have revealed that there are differences in the overall protein content depending on the isolation method. With these information, we are well poised to investigate how EVs from PDR patients and control MH patients alter retinal cell functions and contribute to the disease.

Investigate the role of Retinol Binding Protein 3 (RBP3) in progression of Diabetic Retinopathy (DR) and evaluate its potential as a DR biomarker in Type 2 diabetic patients.

Investigators : Dr. Daipayan Banerjee
Dr. Sagnik Sen
Funding : VISTA Grant

Background

From 1856 when Eduard Jaeger first described the visible retinal changes of Diabetic Retinopathy (DR), there has been a significant progress in understanding the pathology of DR (Wolfensberger and Hamilton 2001). It is demonstrated that anti-VEGF treatment decreases risk of progression of proliferative DR and is routinely used as a treatment regime along with laser photo-coagulation (Simó, Sundstrom et al. 2014, Zhao and Singh 2018). However, till now early stages of DR, namely mild and moderate non-proliferative diabetic retinopathy stages do not have any treatment, other than strict control of blood glucose and lifestyle modification. It is as yet unknown amongst diabetic patients, who will progress to PDR and which patient will continue with no DR or a milder stage of NPDR, and there is an urgent need for novel early disease biomarkers for the same.

The Interphotoreceptor retinoid-binding protein (IRBP) plays a major role in the visual cycle and is critical to the maintenance of photoreceptors (Liou, Fei et al. 1998). Using vitreous samples from diabetic patients with proliferative and non-proliferative diabetic retinopathy (PDR, NPDR) Garcia-Ramírez and colleagues demonstrated that RBP is decreased at early stages of diabetic retinopathy (Garcia-Ramírez, Hernández et al. 2009). Recent reports from Harvard Medical School have shown RBP3 is elevated in Type I diabetic patients those are protected from advanced DR (Sun, Keenan et al. 2011, Yokomizo, Maeda et al. 2019). Further, RBP3 expression is reduced in PDR patients and there is an inverse association between vitreous RBP3 concentration and DR severity. Further, overexpression counters detrimental angiogenic effects of VEGF in rodents.

Very recently, research in AMRF aimed at analysing vitreous proteome of PDR patients to identify novel pathogenic pathways has identified RBP3 to be reduced in PDR samples (10 patients, pooled sample) (Sen et al, 2020 unpublished). While earlier studies have evaluated RBP3 levels in DR

patients with Type I diabetes, the scope of RBP3 as a predictor of DR progression is untested in Type II diabetic patients in India.

Major Objectives

1. Validate reduced RBP3 expression in DR patients with Type II diabetes,
2. Evaluate whether RBP3 can be used as a prognostic tool for DR progression.
3. Understand the mechanism how RBP3 levels are reduced with DR.

Results

1. Vitreous samples are collected from patients with Macular Hole (MH) and Proliferative Diabetic Retinopathy (PDR). The commercial RBP3 antibody (Proteintech, 14352-1-AP) is tested in Y79 cells treated with Simvastatin that is known to up-regulate RBP3 expression.
2. Western blot analysis shows reduced RBP3 in vitreous samples of PDR patients compared to control patients with macular hole (Figure 3).
3. RBP3 immuno-precipitation from vitreous humor has been optimized to conduct shotgun Mass Spectrometry to identify RBP3 binding partners under healthy and diseased condition.

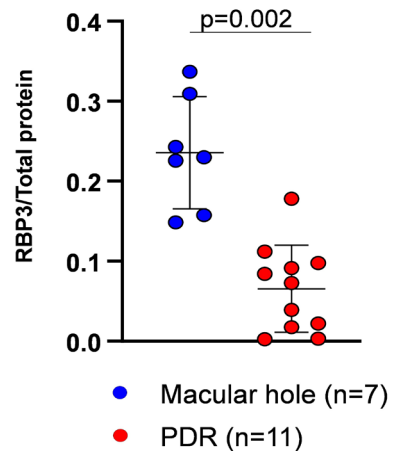

Figure 3: Quantification of RBP3 western blot shows significant reduction in relative RBP3 expression in PDR patients.

Conclusion

Vitreous RBP3 levels in PDR patients with Type II diabetes are reduced compared to vitreous RBP3 in patients with macular hole.

OCULAR PHARMACOLOGY

The main research focus of the Department of Ocular Pharmacology is to understand the molecular mechanism(s) involved in the pathogenesis and to develop a therapeutic targets for the management of glucocorticoid (GC) induced ocular hypertension (OHT)/glaucoma. The funding support from Wellcome-DBT/India Alliance enabled the research team of the department to investigate the role of microRNA in the regulation of GC signaling and to develop miRNA based therapeutics for GC-induced glaucoma (GIG).

Role of microRNA in regulating glucocorticoid receptor signaling in steroid-induced ocular hypertension/glaucoma

Investigators : Dr. S. Senthilkumari,
Department of Ocular
Pharmacology, AMRF, Madurai

Co-Investigators :

- Dr. C. Gowripriya, Department of immunology and Stem Cell Biology, AMRF, Madurai
- Dr. D. Bharanidharan, Department of Bio-informatics, AMRF, Madurai
- Dr. R. Sharmila, Glaucoma Clinic, Aravind Eye Hospital, Madurai

International Collaborator:

- Prof. Colin Willoughby, Faculty of Life & Health Sciences, University of Ulster, Northern Ireland, UK

Mentors:

- Prof. VR. Muthukkaruppan, Research-Advisor, Department of immunology and Stem Cell Biology, AMRF, Madurai
- Dr. SR. Krishnadas, Glaucoma Clinic, Aravind Eye Hospital, Madurai
- Prof. K. Dharmalingam, Research-Director, Department of Proteomics, AMRF, Madurai

Research Associate: Dr. R. Haribalaganesh
Funding Agency :

- The Wellcome Trust-DBT/India Alliance (Intermediate Fellowship)

Introduction

Glucocorticoid-induced glaucoma (GIG) is a secondary glaucoma associated with the chronic use of GCs. Both GIG and primary open angle glaucoma (POAG) share similarities in clinical presentation such as an open angle, increased IOP, characteristic optic neuropathy and loss of peripheral vision. However, the molecular mechanisms for the pathogenesis of GIG is not completely understood (Fini et al., 2017).

MiRNAs are small RNAs which are 21-23 nucleotide long single-stranded RNAs that regulate about 30% of encoding genes. It can interact with the target mRNA 3'-UTR and allow the degradation of mRNA or translation inhibition. In this study, a set of dys-regulated miRNA-mRNA pairs were identified in cultured trabecular meshwork cells derived from experimentally induced glucocorticoid-ocular hypertension (GC-OHT) using next-generation



Table 1: The characteristics of human donor eyes used in the present study

S.No	Group	Code	Age	Sex	Cause of Death	Time B/W Death & Enucleation (h)	Time B/W Enucleation & Culture (h)	Experiment Eye	Treatment
1	GC-R	OCHD19-34	75	F	Heart disease	2.5	52.16	OS	ETH/DEX
2		OCHD20-04	65	M	COPD	0.33	28.5	OS	ETH/DEX
3		OCHD21-01	75	M	Respiratory disease	3.08	84.33	OS	ETH/DEX
4	GC-NR	OCHD19-01	73	M	Natural	4.5	30.8	OS	ETH/DEX
5		OCHD19-08	67	M	Heart disease	2.9	56	OS	ETH/DEX
6		OCHD20-10	38	M	CKD	1.41	47.5	OS	ETH/DEX

sequencing. It is believed that the identified dys-regulated miRNAs may be used as a surrogate marker to determine GC responsiveness prior to treatment and also miRNA based therapeutics are of some potential use in the management of GC-OHT / glaucoma.

The hsa-miR-483-3p expression was found to be up-regulated in HTM cells after being treated with DEX. Previous study by Shen et al., 2015, showed the increased expression of hsa-miR-483-3p has an inhibitory effect on ECM production in HTMCs through down-regulating Smad4 upon oxidative stress. A recent study by Kasetti and his group (2018) showed that SMAD-dependent TGF β signaling pathways have crucial roles in DEX-induced ocular hypertension. Therefore, in the present study, the effect of miR483-3p on the regulation of extracellular

matrix (ECM) protein in GC-responder and GC-non-responder primary HTM cells after DEX treatment was investigated.

A total of 6 (GC-R=3; GC-NR=3) HTM cells with known GC responsiveness were used for this study. HTM cells with known GC responsiveness was established by assessing GC responsiveness in one eye of a paired eye in HOCAS after 100nM DEX treatment and the other eye was used to establish the primary HTM cells. Based on the IOP response, the HTM cells established from each donor eye was categorized as GC-R and GC-NR cells (Table 1).

We first examined the transfection efficiency of mir 483-3p mimic negative after transient transfection in primary HTM cells. Synthetic miRNA mimic negative control were transfected into HTM cells on coverslip after 24h DEX treatment following HiPerfect

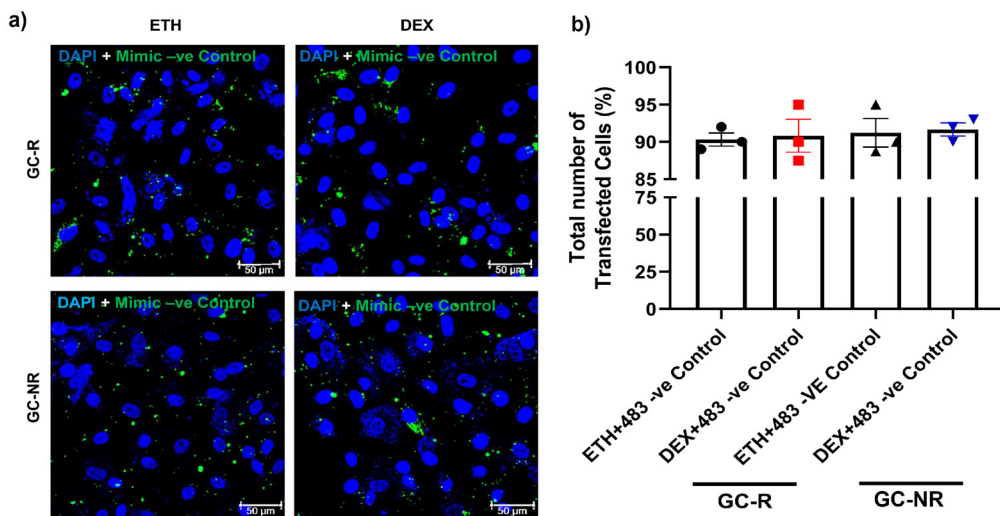

Figure 1. Transfection efficiency analysis in primary HTM Cells. (a) Representative confocal image of hsa-miR-483-3p mimic negative control transfected into GC-R and GC-NR HTM cells; (b) Graph showing the percentage of transfection efficiency in GC-R (n=3) and GC-NR (n=3) HTM Cells. The transfection efficiency was found to be more than 90% with cell viability more than 95%.

transfection protocol. After 24h post-transfection, the HTM cells were fixed and observed under confocal microscopy (Figure 1a). The percentage of transfection efficiency was calculated by using the following formula = No. of transfection positive cells / Total no. of cells (DAPI) X 100. The transfection efficiency was found to be more than 90% (Figure 1b) and the cell viability was found to be more than 95 %.

MiR-483-3p down regulates SMAD4 and TGFβ2 Signaling

Since SMAD4 is the direct target of miR483-3p, we examined whether miR 483-3p targets SMAD4 in HTM cells after DEX treatment. For this, synthetic miRNA 483-3p mimic [5nM, 10nM and 25nM], negative control [5nM] and inhibitor [5 & 10nM] were transfected into GC-R and GC-NR HTM cells after 100nM DEX treatment for 24h. As expected, DEX treatment significantly up-regulated the expression of SMAD4 and the presence of 483-3p mimic

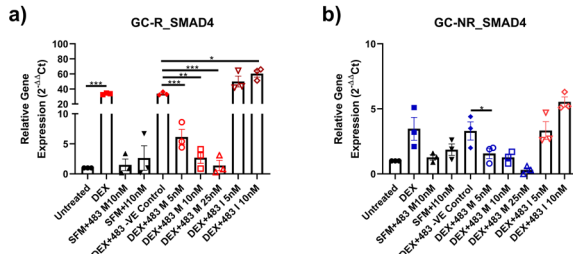

Figure 2. MiR 483-3p directly Targets SMAD4. HTM cells were transfected with hsa-miR-483-3p mimic, mimic negative control and inhibitor after DEX treatment. SMAD4 gene expression in GC-R HTM cells (n=3) (a); GC-NR HTM cells (n=3) (b). Data represent mean ± SEM; *p < 0.05. **p < 0.001; ***p < 0.0001.

down-regulated the SMAD4 expression in a dose-dependent manner. The presence of 483-3p inhibitor showed up-regulation of SMAD4 expression (Figure 2a & b). Interestingly, the down-regulation of smad4 by miRNA 483-3p mimic is more prominent in GC-R HTM cells as compared to GC-NR cells. These results indicate the 483-3p directly targets SMAD4 and its expression was modulated by the presence of mimic and inhibitor.

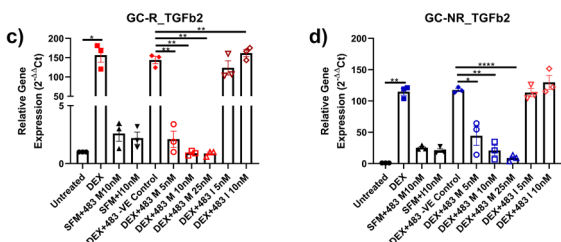

Figure 2. Effect of MiR 483-3p on TGFβ2. HTM cells were transfected with hsa-miR-483-3p mimic, mimic negative control and inhibitor after DEX treatment. TGFβ2 gene expression in GC-R HTM cells (n=3) (c); GC-NR HTM cells (n=3) (d). Data represent mean ± SEM; *p < 0.05. **p < 0.001; ****p < 0.00001.

TGFβ signaling is well implicated in glaucoma. The elevated levels of TGFβ2 was found in the aqueous humor of patients with primary open angle glaucoma and also over expressed in dexamethasone induction (Yemanyi et al.,2020). Previous study also documented that SMAD-dependent TGFβ signaling have a crucial role in DEX-induced OHT (Kasetti et al., 2018). Therefore, in the present study, the effect of miR483-3p on TGFβ expression was investigated. As expected, DEX treatment elevated TGFβ2 expression in both GC-R and GC-NR HTM cells.

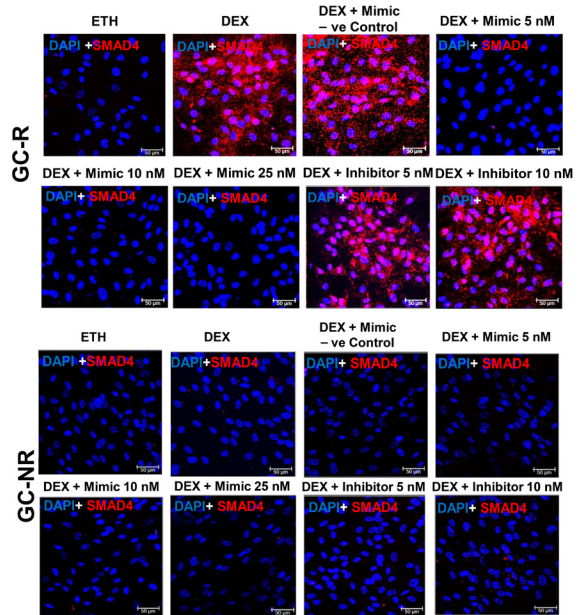

Figure 3. MiRNA-483-3p Targets SMAD4 in HTM Cells. Representative confocal image of SMAD4 protein expression in hsa-miR-483-3p mimic, negative control and inhibitor transfected GC-R and GC-NR HTM Cells after DEX treatment. Blue: DAPI (Nucleus); Red: SMAD4

The presence of 483-3p mimic down-regulated TGFβ2 expression in a dose-dependent manner. The presence of 483-3p inhibitor showed up-regulation of TGFβ2 expression (Figure 2c & d).

The above findings were further confirmed by immunofluorescence analysis of SMAD4 (Figure 3) and TGFβ2 (Figure 4) and western blotting (Figure 9)

Effect of miR483-3p on ECM Proteins (Collagen 1A, Fibronectin and Laminin5) Expression

RT-qPCR Analysis

In HTM cells, DEX treatment induces the expression of ECM proteins. Therefore, the effect of miR483-3p on ECM regulation was studied in GC-R and GC-NR HTM cells. As expected, DEX treatment increased the expression of Col1A, fibronectin and laminin5 which was down-regulated by the presence of miR483-3p mimic in both GC-R and GC-NR cells (Figure 5). This

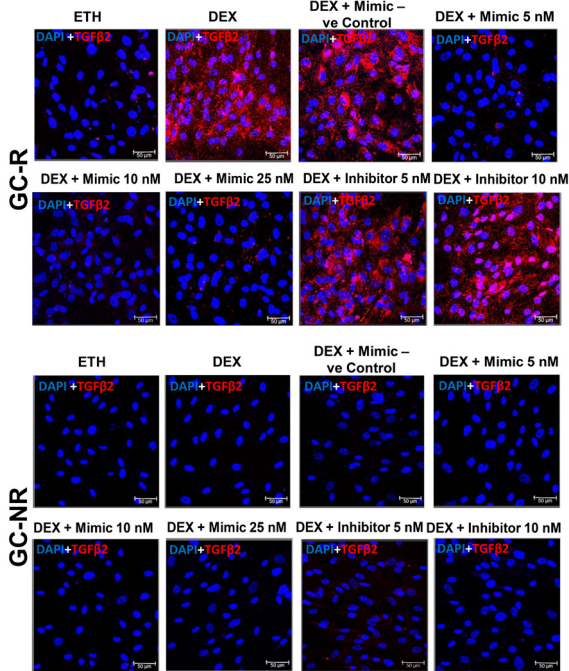

Figure 4. Effect of MiRNA-483-3p on TGFβ2 in HTM Cells. Representative confocal image of TGFβ2 protein expression in hsa-miR-483-3p mimic, negative control and inhibitor transfected GC-R and GC-NR HTM Cells. Blue: DAPI (Nucleus) ; Red: TGFβ2

Immunofluorescence Analysis of ECM Proteins

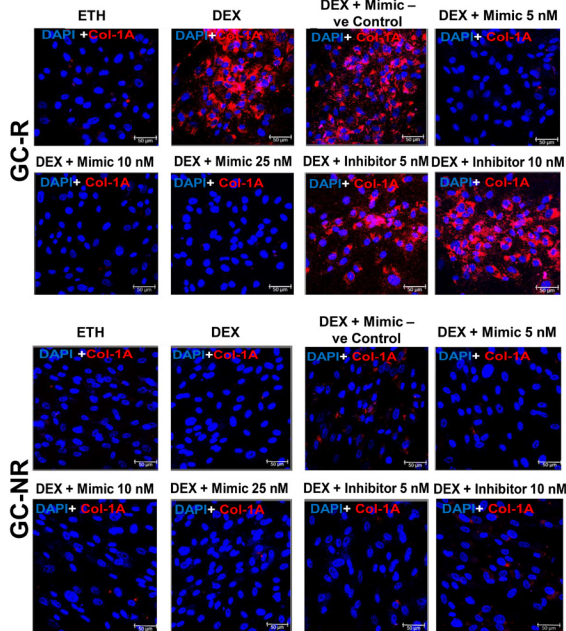

Figure 6. Effect of MiRNA-483-3p on Collagen 1A expression in HTM cells. Representative confocal image of Collagen 1A protein expression in hsa-miR-483-3p mimic, negative control and inhibitor transfected GC-R and GC-NR HTM Cells. Blue: DAPI (Nucleus); Red: Collagen 1A

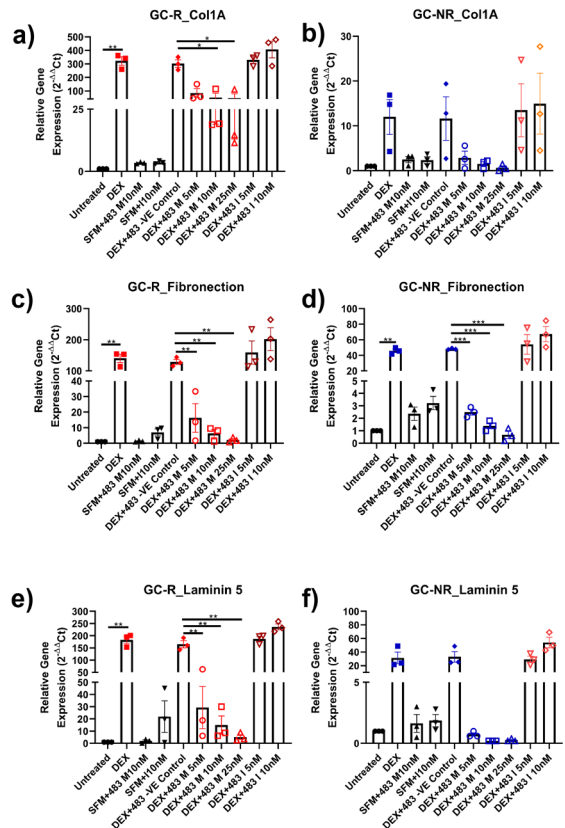

Figure 5. Effect of miR483-3p on ECM genes by qPCR Analysis. HTM cells were transfected with hsa-miR-483-3p mimic, mimic negative control and inhibitor after 100nM DEX treatment. Total RNA was extracted, converted to cDNA and the Collagen 1A, Fibronectin and Laminin5 gene expression were carried out by qPCR, gene expression were normalized to ACTB and analysed using the $2^{-\Delta\Delta C_t}$ method. Collagen 1A gene expression in GC-R HTM cells (n=3) (a); GC-NR HTM cells (n=3) (b). Fibronectin gene expression in GC-R HTM cells (n=3) (c); GC-NR HTM cells (n=3) (d). Laminin5 gene expression in GC-R HTM cells (n=3) (e); GC-NR HTM cells (n=3) (f). Data represent mean \pm SEM; *p < 0.05. **p < 0.001; ***p < 0.0001

was further confirmed by IF (Figure 6-8) and western blot (Figure 9). Interestingly, the down-regulation of ECM proteins by miR483-3p was more pronounced in GC-R and GC-NR HTM cells.

Conclusion

DEX treatment elevated IOP through SMAD4/TGFβ2 signaling which resulted in the enhanced production of ECM proteins such as Col1A, fibronectin and Laminin5. The presence of miR483-3p down-regulated SMAD4/TGFβ2 signaling and hence decreased the production of ECM proteins in HTM cells (Figure 10). Interestingly such down-regulation is more prominent in GC-R HTM cells as compared to GC-NR cells. Therefore, the up-regulation of miR483-3p and subsequent down-regulation of its target Smad4 may serve as a protective mechanism to regulate ECM proteins in HTM cells upon DEX treatment.

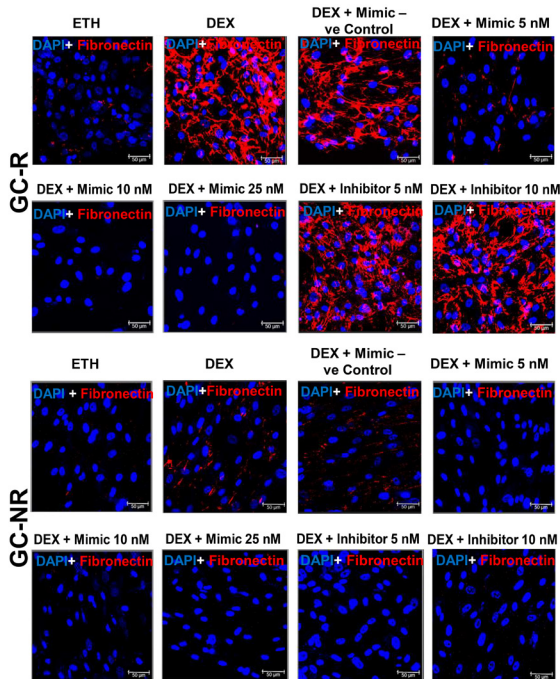

Figure 7. Effect of MiRNA-483-3p on Fibronectin expression in HTMCs. Representative confocal image of Fibronectin protein expression in *hsa-miR-483-3p* mimic, negative control and inhibitor transfected GC-R and GC-NR HTM Cells. Blue: DAPI (Nucleus); Red: Fibronectin

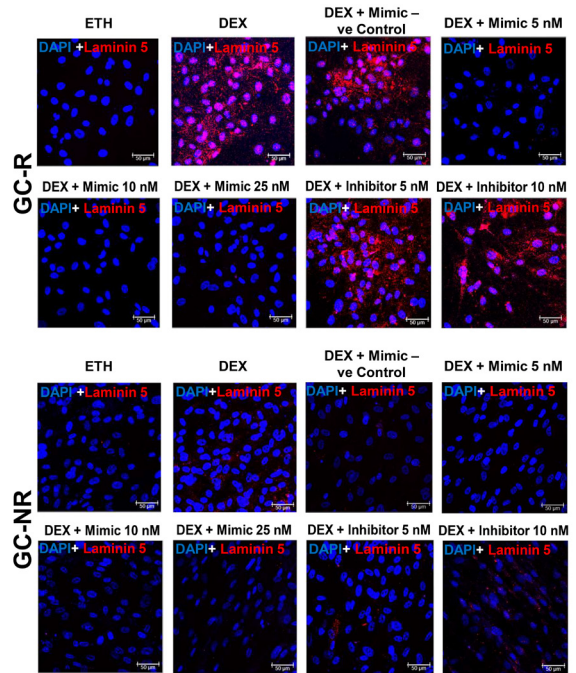

Figure 8. Effect of MiRNA-483-3p on Laminin5 expression in HTM Cells. Representative confocal image of Laminin5 protein expression in *hsa-miR-483-3p* mimic, negative control and inhibitor transfected GC-R and GC-NR HTM Cells. Blue: DAPI (Nucleus); Red: Laminin5

Western blot Analysis of SMAD4, TGFβ2 and ECM Proteins

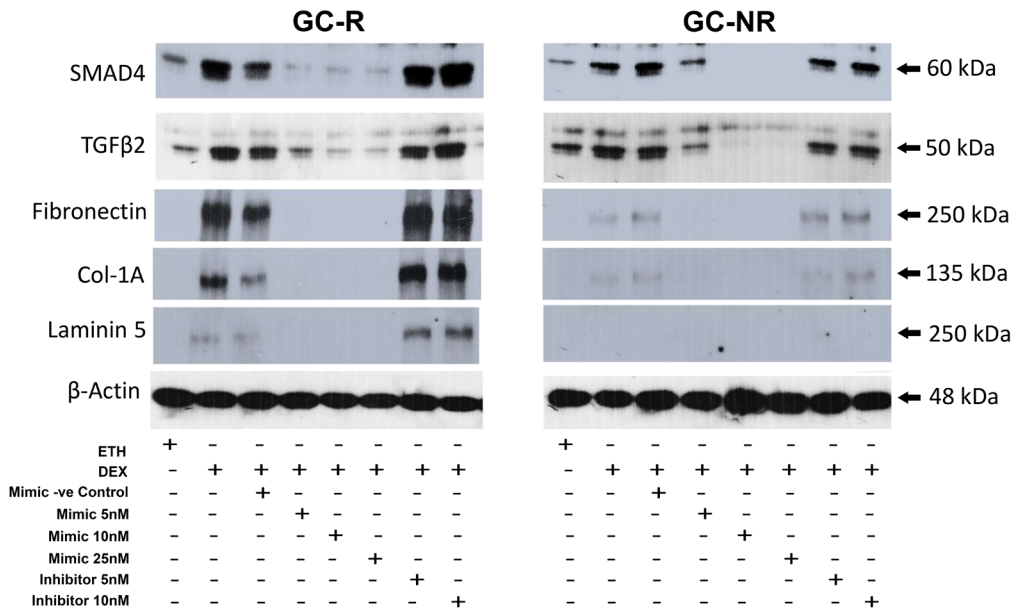

Figure 9. Western blot analysis of SMAD4, TGFβ2 and ECM proteins after transfection of *miR 483-3p* in GC-R and GC-NR HTM cells. Proteins were detected with specific antibody, β-actin was used as a loading control.

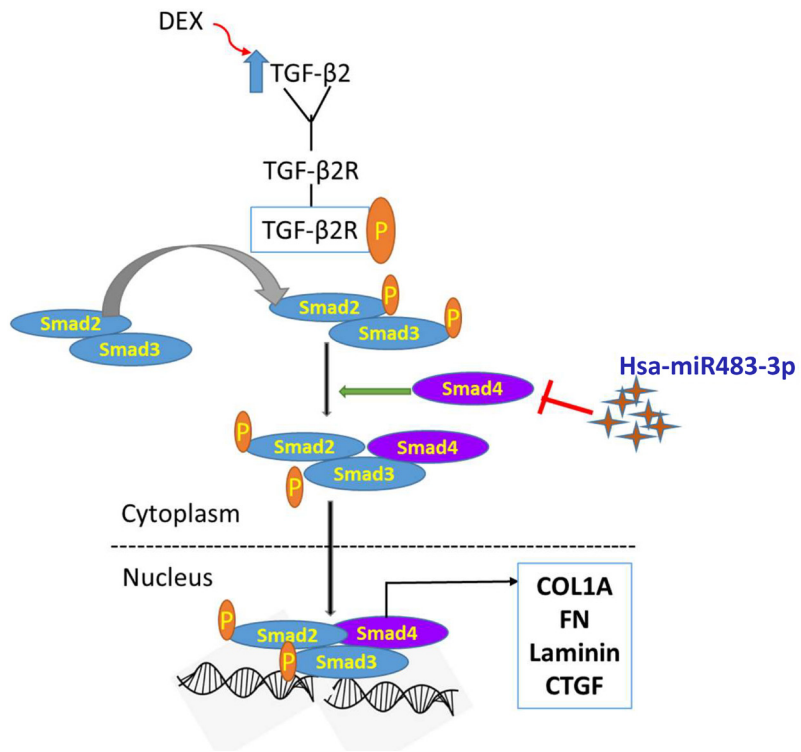

Figure 10. Schematic Representation of the Effect of miR483-3p on ECM Regulation

BIOINFORMATICS

Clinical Exome/Genome analysis for eye diseases

Investigators : Dr. D. Bharanidharan
Dr. P. Sundaresan,
Dr. A. Vanniarajan
Research Scholar : K. Manojkumar
Funding : DBT-COE, SERB

Background

The inheritance of eye diseases, which is attributed to deleterious genetic alterations, is dependent on a large population or the aggregation of a disease across generations. The first step toward developing genetic screening tests and novel therapeutic interventions is identifying deleterious genetic alterations that contribute to Mendelian and complex eye diseases. Recent advances in genomic technologies, particularly next generation sequencing (NGS) methods, have brought a paradigm shift in discovering eye disease-associated genetic variants from linkage and genome-wide association studies to NGS-based genome/exome studies. Spurred by NGS technologies, new efficient and well-designed bioinformatics tools emerged which are addressing different tasks in the downstream analysis of NGS data. Since combining these tools into an analysis pipeline greatly facilitates the interpretation of NGS results, an exome/genome sequencing pipeline is developed in this project that connects all necessary analysis steps into a unified application in the clinical settings for eye disease panel. The pipeline

support input data generated by the NGS Illumina and MGI platforms, handles correct execution of all integrated tools. It performs quality statistics on raw and processed reads, allows users to trim and filter sequence reads, and aligns the processed reads to a reference eye disease gene panel. The pipeline deal single nucleotide variants (SNVs) and short INDELS separately to improve the performance and to detect true positives. The integration of well-established tools and newly developed promising algorithms into a unified solution eases the analysis of next-generation exome/genome sequencing data. However, identifying the pathogenic (disease-causing) variants from thousands of variants in WES and WGS data is limiting the NGS studies. Here, we have developed Variant Prioritization (VarP) ML model to predict the pathogenic variants.

Results and Conclusions

Our updated automated pipeline is available at github online link : <https://github.com/bharani-lab/WES-pipelines/>. The VarP method was developed by combining both heuristic filtering and the machine learning model to filter the pathogenic variants as shown in Figure 1. The ML method was selected after evaluating the two commonly used ML methods Random Forest (RF) and Support Vector Machine(SVM). The VarP was trained using 9431 genes containing 34,361 disease-causing variants collected from Human Gene Mutation Database (HGMD) database and 89,694 common variants from the 1000Genome Project. Both the model was cross-



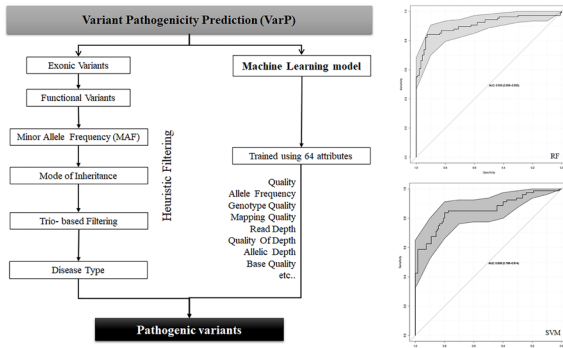

Figure 1. Schematic representation of VarP and ROC of SVM and RF

validated using k-cross-validation (Figure 1). Based on the cross-validation and the area under the curve (AUC) results, we chose RF as the Best model for the VarP. The final VarP method showed an accuracy of 0.944 in predicting the pathogenic variants.

In conclusion, we have successfully developed model that predict pathogenic variants with high sensitivity from whole genome and exome data. Further, we are developing eyeVarP (eye disease associated variant prioritization) tool for prioritization of pathogenic variants associated with eye diseases.

Identification and Analysis of Alternative Transcripts in Retinoblastoma Progression

Investigators : Dr. D. Bharanidharan
 Dr. A. Vanniarajan, Dr. Usha Kim
 Funding : DBT
 Research Scholar : Mohamed Hameed Aslam A.

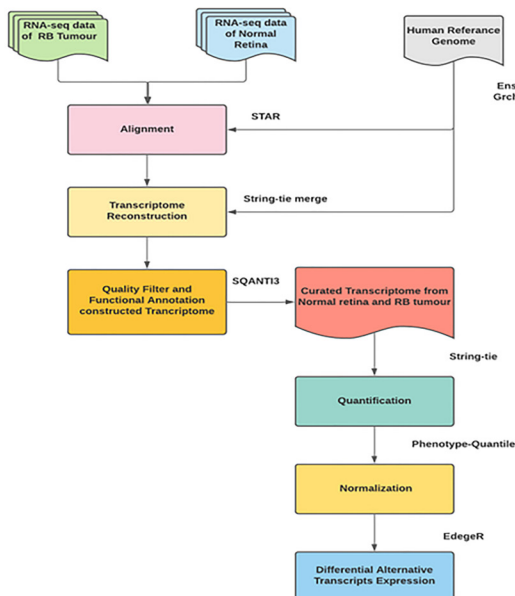

Retinoblastoma (RB) is the most common intraocular cancer in children, caused by loss of function in both alleles of the Retinoblastoma tumor suppressor gene (RB1). Cancer causes numerous genetic changes, but very few changes drive tumor progression, which can be identified by differential gene expression. Alternative transcripts start site (ATSS), alternative transcripts termination (ATT), alternative splicing and translation of untranslated regions promote tumour progression in cancer. Here, we have investigated the differential expression of alternative transcripts and its functional characterization using Transcriptome Data of control retina and Retinoblastoma tumour. Further, we have reconstructed transcripts annotation from the RNAseq to identify novel alternative transcripts. In addition, the reconstructed transcriptome is corrected and curated with the help of bioinformatics annotation tools, and database specific to alternative transcripts helps to reduce false positive novel alternative transcripts. Finally, we have analyzed differential alternative transcripts using reference-guided reconstructed annotation. The analysis pipeline workflow is depicted schematically in the figure.

Results and Conclusion

Metaanalyses of RNAseq data at the gene and transcript level were performed to remove batch effects and other confounding variables caused by diverse public datasets from various studies. After

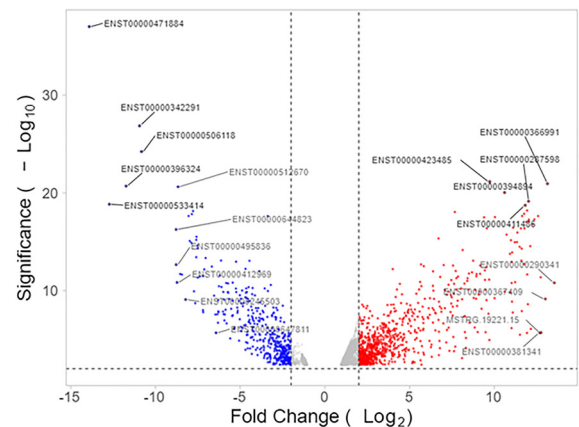

Figure 2.1 : Differential Expression of Alternative transcripts in RB Tumor and Normal Retina

quality testing and functional filtering based on multi-omics databases, we filtered out 116 unique alternative transcripts. Alternative transcripts that were differentially expressed or dysregulated were identified using a standard cut-off fold change more than 2, less than -2, and FDR<0.01 which is represented in Figure 2.1.

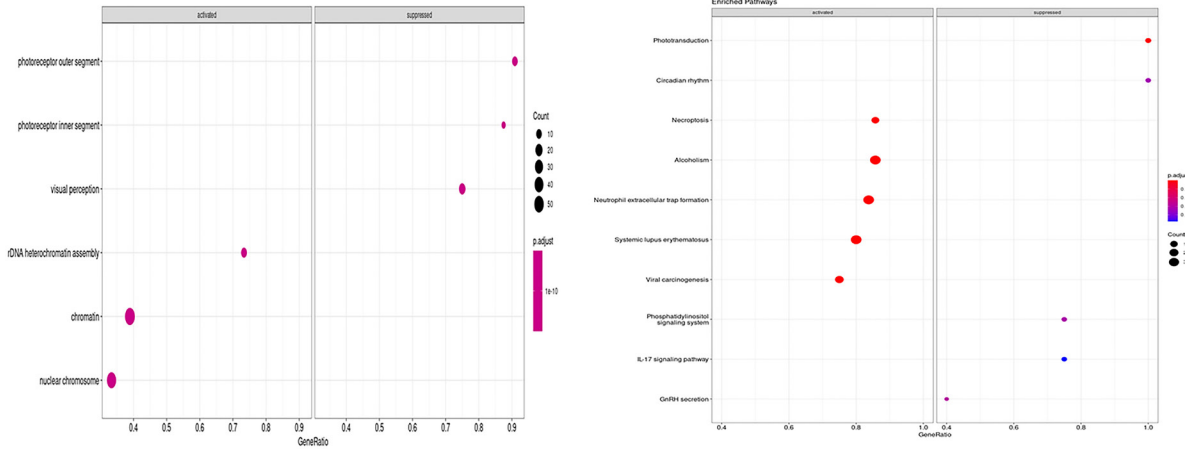

Figure 2.2: KEGG (left) and GO (right) Enrichment Analysis of Dysregulated Alternative Transcripts.

Furthermore, the differentially expressed alternative transcripts were subjected to functional enrichment analysis (Figure 2.2). The analysis from KEGG and GO depicted several pathways unique to photoreceptor function, circadian regulation, epigenetic modification and inflammation. The pathways outer segment formation, phototransduction, visual perception were highly distinct to photoreceptors. The circadian desynchronization, in particular, enhances phosphorylation of the retinoblastoma (RB) protein, encouraging cell cycle progression through the G1/S phase¹. Epigenetic modification such as DNA methylation, heterochromatin remodelling

are aberrantly regulated during cancer. The progression of retinoblastoma is evident from the loss of photoreceptor function, circadian regulation and upregulation of epigenetic pathways. It was noted that many inflammatory and immunomodulatory pathways such as Necroptosis, Neutrophil extracellular trap formation and Systemic erythematosus lupus were upregulated in our analysis. This could be due to the effect of aberrant inflammatory signalling during cancer progression and angiogenesis which could lead to tissue damage. The role of alternative transcripts in the progression of Retinoblastoma is evident from the enrichment of above pathways, which requires further evaluation.

OCULAR MICROBIOLOGY

Diagnostic markers for Intra-Ocular Tuberculosis

Investigators : Dr. D. Bharanidharan,
Dr. SR. Rathinam, Dr. Lalitha
Prajna
Research Scholar : C. Swathi
Funding : DBT, ICMR-SRF

Background

Ocular tuberculosis can present with extraocular or intraocular inflammation, the most common manifestation being uveitis. The differential diagnosis of Intraocular TB is challenging because it is a great mimicker of various uveitis entities. Moreover, the limited size of ocular fluids and the paucibacillary nature of ocular *M. tuberculosis* infection create additional barriers in the diagnosis. The diagnosis is only presumptive and corroborated by laboratory tests and therapeutic response to Anti-TB treatment (ATT). These leads to undiagnosed TB uveitis carry a risk of high visual morbidity. Moreover, overzealous ATT treatment in the absence of TB infection carries a significant risk of systemic side effects. Therefore, advanced molecular markers in the diagnosis of ocular tuberculosis are required. MicroRNAs are expressed in various ocular tissues and have been implicated in various eye diseases, owing to their distinct tissue and disease-specific regulation as well as high sensitivity and specificity. Expression of miRNAs targeting dysregulated proteins can complement RNA based biomarkers in ocular tuberculosis. Although various studies have

discussed the potential use of mRNA and protein-based biomarkers in the diagnosis of pulmonary tuberculosis, none of them have addressed it in the context of ocular tuberculosis.

Results and Conclusions

Potential ocular TB – specific miRNAs were identified and validated in AH samples using small-RNA sequencing and qPCR from the low-volume of aqueous humor (AH) of ocular TB patients and cataract as control. Four miRNAs miR-423-5p, miR-328-3p, miR-21-5p, and miR-16-5p were significantly differentially expressed in TB patients compared to cataract controls using AH samples. Five enriched pathways mTOR signaling pathway, MAPK signaling pathway, PI3K-Akt signaling pathway, tuberculosis, and autophagy were identified based on the pathway analysis of four miRNAs predicted targets. Further, network analysis and TB-related literature identified fifteen genes that may have role in the ocular TB pathogenesis, requires further expression analysis in ocular TB. In tandem, the small-RNA sequencing was performed using vitreous humor (VH) of ocular TB and Macular hole patients as controls. Based on the abundance and fold change, we selected 14 miRNAs as significantly differentially expressed. Among fourteen miRNAs, selected from NGS data, three miRNAs hsa-miR-150-5p (Fold Change (FC), 3.0), hsa-miR-26b-5p (FC, 2.1) and hsa-miR-21-5p (FC, 3.8) were matching with in qPCR data (Figure 1.1) were significantly upregulated in VH of OTB patients compared to macular hole samples.



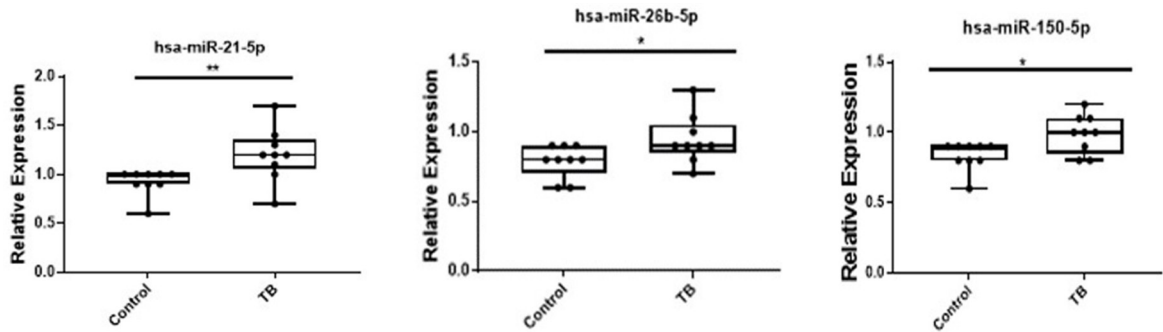

Figure 1.1. Relative expression values of IOTB VH samples (n = 9) compared to macular hole (n = 9) samples. P-value was calculated using the Mann-Whitney test. *P <0.05, **P <0.01

Table 1.1. Top ten pathways enriched in IOTB

S.No	KEGG Pathway Name	Genes	P-value
1.	*MAPK signaling pathway	48	3.00E-07
2.	*TGF-beta signaling pathway	21	2.20E-05
3.	Hepatitis B	29	3.80E-05
4.	*Wnt signaling pathway	27	1.10E-04
5.	*Cell cycle	25	1.30E-04
6.	*PI3K-Akt signaling pathway	48	1.10E-03
7.	Chronic myeloid leukemia	16	1.10E-03
8.	Axon guidance	23	1.20E-03
9.	*Long-term potentiation	15	1.30E-03
10.	*Sphingolipid signaling pathway	22	1.30E-03

*Pathways were selected for further analysis based on their role in TB pathogenesis.

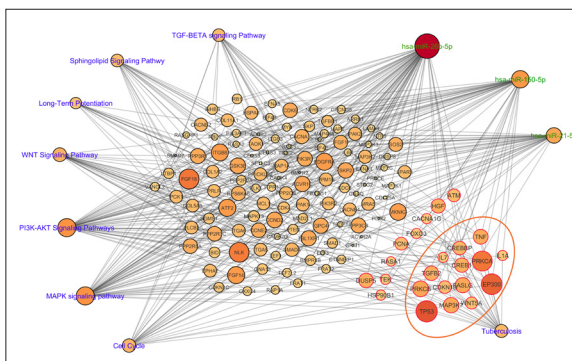

Figure 1.2. miRNAs-target genes regulation network of the selected pathways in VH. The selected Three miRNAs and their target genes having higher closeness centrality were marked with an orange to red color circle; the intensity of the color corresponds to the level of the closeness centrality. Gene names colored with red are associated with the tuberculosis pathway. The orange circle represents the genes selected for further RT-qPCR validation.

The target gene prediction was performed using miRWalk 3.0 database and filtered based on the three other databases. The functional enrichment analysis was performed with DAVID 6.8 and g: Profiler. The table 1.1 shows the top ten enriched pathways through GSEA (gene set enrichment analysis).

Of the ten pathways, seven pathways as shown in table 1.1 is of interest, which were plotted as functional network using cytoscape (figure 1.2).

Conclusion

In addition to miRNA markers identified from AH samples, we identified three miRNAs miR-150-5p, miR-26b-5p, and miR-21-5p as potential TB-specific miRNAs in VH. Further analysis on their target genes and validation in large cohort will allow us their potential role in IOTB diagnostics

3. Comparative genomics of bacterial pathogens isolated from keratitis patients

Investigators : Dr. D. Bharanidharan,
Dr. Lalitha Prajna

Research Scholar : K. Kathirvel

Funding : AEH

Background

Bacterial keratitis, often caused by Pseudomonas aeruginosa and methicillin-resistant staphylococcus aureus (MRSA), has a complex pathogenesis process. Majority of times in spite of adequate medical management the ulcer does not heal and may require a corneal transplant. Several virulence factors, multiple drug resistance mechanisms and altered host response has been implicated in the treatment failure. Comparative genomics through de novo assembly of next-generation sequencing and third-generation sequencing methods of ocular bacterial pathogens will show genetic features specific to the causative organism. Our genome

analysis of ocular methicillin-resistant *Staphylococcus aureus* (MRSA) showed that the strains possess a plasmid that harbors a complete Tn552 transposon with β -lactamase genes and cadmium resistance genes. In addition, the sequence type-specific resistance and virulence genes provide multi-drug resistance, enterotoxigenic, exotoxigenic, biofilm-forming, host tissue adhesion and immune response evasion in ocular MRSA strains. On the other hand, our genome analysis of ocular *P. aeruginosa* strains from keratitis patients highlighted that the multi-drug resistance *P. aeruginosa* keratitis strains carries ExoU and non-MDR strains carries ExoS for their virulence. In addition, the MDR strains carries several antimicrobial resistance-associated genes that provide the different antimicrobial resistance mechanism for ocular strains including enzymes targeting antibiotics, mutations that provide poor antibiotic binding and efflux pumps, which requires further analysis and experimental validation

Results and Conclusion

Several non-synonymous point mutations were detected in transcriptional regulator genes *mexR*, *nalC*, *nalD*, periplasmic membrane fusion protein *mexA* and inner membrane drug-proton antiporter *mexB*, that govern the expression of MexAB-OprM pump. A *mexR* gene mutation V126E detected in *exoU* carrying *P. aeruginosa* strains, was reported to cause overexpression of the MexAB-*oprM* pump and thus increase the resistance to fluoroquinolones (Lee et al., 2005; Subedi et al., 2018). Also, *nalC* mutations, G71E and S209R were detected mostly in all the strains. Interestingly, three novel strain-specific mutations L85P, N130S and G206S of *nalD*, a secondary repressor of the MexAB-OprM system, were detected in three strains BK6, BK4 and BK2, respectively. A study showed that mutations in the *nalD* gene might overexpress MexAB-OprM efflux system (Sobel et al., 2005). Further the identified mutations were also confirmed by sanger sequencing. In addition, the impact of mutations in the expression of MexAB-OprM efflux genes were also profiled by qPCR (Figure 2.1)

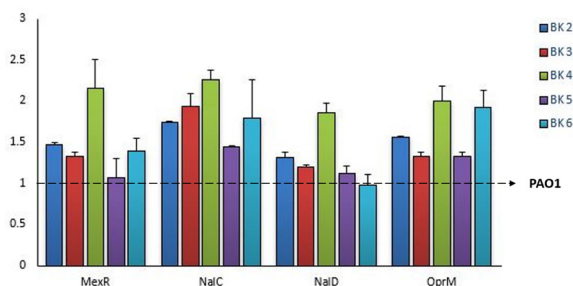

Figure 2.1 Expression profile of MexAB-OprM efflux pump genes in six ocular *P. aeruginosa* strains BK2-BK6 compared to PAO1.

Conclusion

We show that ocular *P. aeruginosa* strains widen their drug resistance profiles by affecting the repressors through mutations to overproduce efflux pumps.

Role of Human corneal miRNAs in the onset and severity of Fungal Keratitis

Investigators : Dr. D. Bharanidharan
Dr. K. Dharmalingam,
Dr. Venkatesh Prajna,
Dr. Lalitha Prajna

Research Scholar: Shreya Dinesh

Funding : ICMR

Introduction: In India, corneal lesions account for 9% of all blindness. (Govt. of India. National Survey on blindness. 1999-2001. Report 2002). Our recent data on a total of 6320 corneal ulcer patients for three years (2016-2018) showed that 66% of the microbial keratitis was a fungal infection. Nearly 40% of fungal keratitis patients require surgical intervention, which in turn has a relatively poor prognosis (Prajna, et al 2017), suggesting that identification of disease severity is essential for better treatment management. Recent reports on altered miRNA expression in human corneal diseases indicate their regulatory role in pathogenesis (Yang et al. 2014, Hemadevi et al., 2015; Muraleedharan et al., 2016; Derrick et al., 2017). We reported that miR-155-5p was dysregulated in *A. flavus* keratitis human corneas. We also reported miR-223-3p and miR-451a-5p might play an important role in corneal wound inflammation (Hemadevi et al., 2015). However, the role of the miRNAs in *Fusarium* keratitis and their role in the severity of fungal keratitis is not studied.

Results and Conclusion

Totally, 192 corneal tissue samples were collected. Of these, 83 tissue samples from keratitis patient samples who were culture positive for *A. flavus*, *Fusarium* species and *P. aeruginosa* were taken forward for the downstream experiments. Also, ten cadaver normal corneal tissues were used for the controls. Similarly, 80 swab samples were collected at the patient's first presentation and at the first review (7-10 days) after treatment were used in this study. After many trials and failures, 33 samples were sequenced at Biokart company. Of these, sixteen samples, based on their read counts selected for the further analysis, were grouped into five groups with at least three samples per group, including control, healed group (*A. flavus*), poor outcome (*A. flavus* non-responders), poor outcome (*Fusarium* sp.

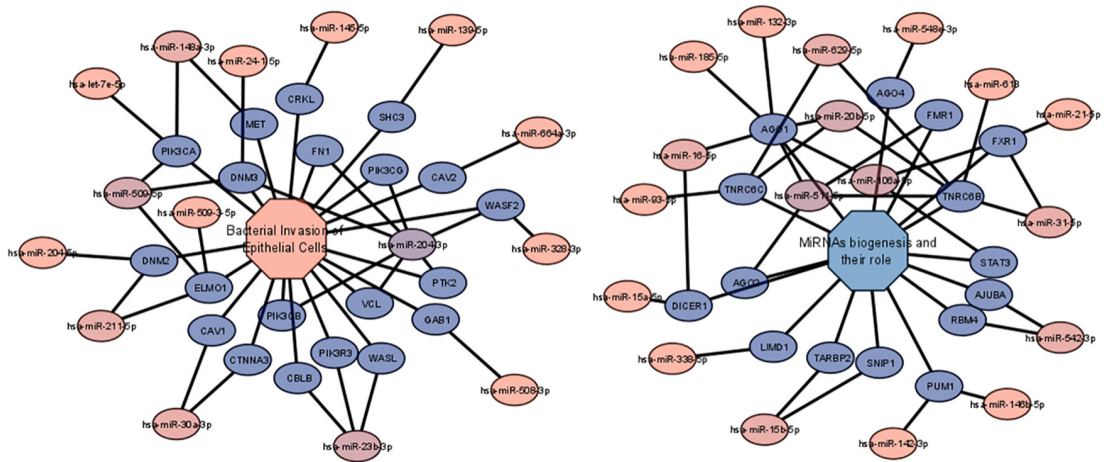

Figure 3.1. The miRNA-target pathway network for the selected pathway and GO-biological process

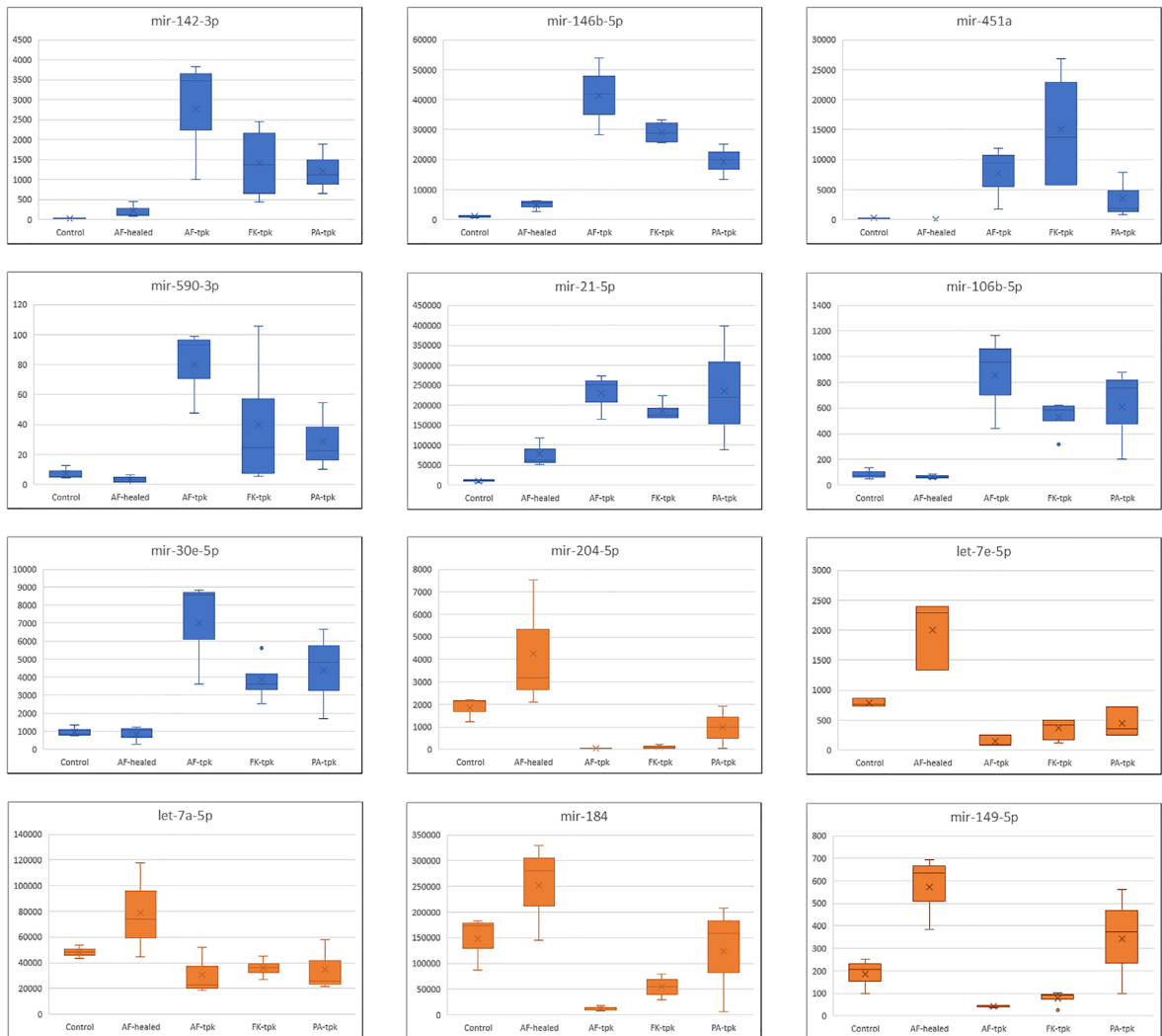

Figure 3.2. Putative markers for responders and non-Responders. The raw counts of control, *A. flavus* and *Fusarium sp.* Infected corneal tissues after surgery, and *A. flavus* infected corneal swabs from healed patients were plotted.

Non-responders) and poor outcome (*P. aeruginosa* Non-responders). The differential expression analysis was performed between each of the two groups. The DE miRNA were filtered based on the following criteria, log fold change $> \pm 2$; $-\text{Log}_2\text{P-value} > 2$ and $\text{LogCPM} > 4$ from each two-group analysis. Target prediction and functional analysis was performed on these selected DE miRNAs.

The functional analysis showed that most of the top dysregulated pathways and biological processes (GO) were common among both fungal species in the non-responders group, suggesting their role in fungal keratitis pathogenesis. Of these pathways, Foxo signaling, Axon guidance, Neurotrophin signaling pathway, MAPK signaling have been reported earlier in fungal keratitis. In addition, we identified several unique pathways and GO regulated by upregulated and downregulated miRNAs targets separately. Of our interest, we selected upregulated Bacterial invasion of epithelial cells pathway and

downregulated biological process that affects the miRNA biogenesis and their role by downregulated miRNAs and upregulated miRNAs, respectively. We selected a list of putative markers from the chosen pathway and GO (Figure 2.1), which had highly abundant expression pattern with high fold change. They were hsa-Mir-146b-5p, hsa-Mir-142-3p, hsa-Mir-21-5p, hsa-mir106b-5p, hsa-Mir-30e-5p, let-7e-5p and hsa-Mir-204-5p. In addition, we selected significant DE hsa-Mir-451a, hsa-Mir-590-3p, has-Mir-184, let-7a-5p and has-Mir-149-5p based on their differential expression profile of fungal disease groups compared to healed, control and *P.aeruginosa* keratitis group.

Conclusion

The list of putative miRNA markers identified in this study will be further validated in large sample size of fungal keratitis patients, which can yield a set of specific biomarkers in response to *Aspergillus* or *Fusarium* spp. Infection.

CONFERENCES / MEETINGS

Annual meeting of International Society of Stem Cell Research (virtual) 2021

June 21-26

The following members of the Department of Immunology and Stem Cell Biology, Aravind Medical Research Foundation attended the meeting and presented their research work as posters.

Dr. C. Gowri Priya

- Hsa-miR-143-3p inhibits MAPK signaling in human corneal epithelial stem cells

A. Waseema

- Localization of stem cells in native human Retinal Pigmented Epithelium

R. Iswarya

- Integration of cultured human trabecular meshwork (TM) stem cells to TM in a cell loss human anterior segment organ culture (HOCAS) model

ARVO- IC –Indian Eye Research Group (IERG) 2021 (Virtual)

LV Prasad Eye Institute, Hyderabad, October 7-10

A total of twenty seven participants including Faculty and research scholars from AMRF attended the meeting. Scientists participated as Chair Persons/ Moderators while research scholars presented their work as free papers and posters. At the meeting, AMRF conducted a workshop on Ocular proteomics. Prof. K. Dharmalingam, Director-AMRF moderated the workshop. He also moderated a special session titled Best of AMRF 2019-21.

- Dr. P. Sundaresan was the panelist for the workshop on Ocular gene therapy. He also chaired the free paper session on *Genetics*.

- Dr. C. Gowri Priya chaired the keynote session on *Ocular inflammation*
- Dr. S. Senthil Kumari chaired the session on *Glaucoma research*
- Dr. A. Vanniarajan chaired the session on *Oncology and cell biology*
- Dr. J. Jeya Maheshwari chaired the session on *Tissue engineering and drug delivery*

Free paper Presentations

1. Dr. Haribalaganesh: Genome-wide transcriptome profiling of glucocorticoid responder and non-responder primary human trabecular meshwork cells using RNA-sequencing after dexamethasone treatment
2. Swathi Chadalawada : Dysregulated expression of micro RNAs in vitreous humour from intra-ocular tuberculosis patients
3. Iswarya Radhakrishnan: Transplanted Trabecular Meshwork (TM) stem cells home to TM – A study in cell loss Human organ culture anterior segment (HOCAS) model of Glaucoma
4. Pon Yazhine: Exoproteome of clinical isolates of *Fusarium solani*
5. Sumaiya Sirajudeen: Differential response of corneal epithelial and stromal cells to the novel chemical cross-linker treatment
6. Susan Immanuel: Isolation and characterization of exosome mimetics from human corneal epithelial cells

Poster Presentations

1. Dr. Siddharth Narendran : Mechanotransduction and retrotransposons in Age-related macular degeneration

Virtual participation of AMRF Faculty and students in IERG meeting



2. Sriee Viswarubhiny: Targeted panel-based gene screening for a large cohort of patients with LCA in Southern India
3. Prakash Chermakani: Whole mitogenome/exome sequencing of LHON patients uncovers mutations in Mito-nuclear genes associated with OXPHOS complex I impairment
4. Saranya P: Loss of adult stem cell in cataractous human anterior lens epithelium
5. T. Shanthini: Molecular regulators of retinoblastoma tumor progression
6. Susmita Chowdhury: Clinical reassessments and whole-exome sequencing uncover novel BEST1 mutation associated with Bestrophinopathy phenotype
7. Waseema Arif: Adult stem cells for human retinal pigment epithelium are present in its peripheral region
8. Sarawathi K: Clinical features and survival outcomes of ocular adnexal lymphoma in South Indian cohort

INVITED TALK

On the occasion of National Science Day 2022, Prof. K. Dharmalingam, delivered a lecture on *Genome resources for a sustainable future* at Avinashilingam Institute for Home Science and Higher Education for women, Coimbatore on February 28, 2022.



Prof.K.Dharmalingam at Avinashilingam Institute for Home Science and Higher Education for women, Coimbatore

Dr.P.Sundaesan delivered the Silver Jubilee Endowment lecture on *Discovery of genes causing blindness and gene therapy* on 11th March 2022 at the University of Madras, Chennai on March 11, 2022.

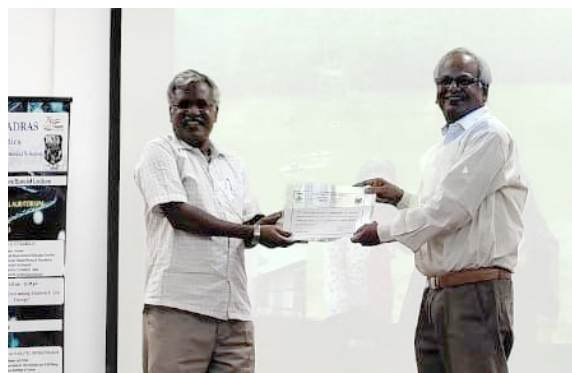

Dr.P.Sundaesan at University of Madras, Chennai

CONFERENCES CONDUCTED

Workshop on Leveraging Clinical Genomics to improve Human Health

August 27, 2021

AMRF and Premas Life Sciences jointly organised this one-day workshop to update the participants on the recent developments in next generation sequencing. The workshop was conducted in a hybrid mode and a total of 40 participants including faculty members and research scholars took part.

International Workshop on Data Science and Modern Biology

December 20-21, 2021

The workshop was planned as a refresher course for young researchers with an aim to update them on the current avenues in the field of modern biology. Along with lecture sessions by experts, two semi- hands on practical sessions were included, which were beneficial for the research scholars. It was conducted in a hybrid mode with 70 participants attending in person and guest lectures and practical sessions conducted online.

Since one of the objectives of the workshop was to inculcate research aptitude in young scholars, a special session was organised for their interaction with experts. The workshop on Single cell-omics and spatial transcriptome profiling handled by Premas Life Sciences introduced the new field of Visium technology for transcriptome studies using archival samples. Another workshop on “Nanostring technology” by TheraCues team covered the different aspects of gene expression studies, from sample preparation to data generation along with its utility in disease biology.



Participants of the "International Workshop on Data Science and Modern Biology"

19th Research Advisory Committee Meeting

26th March 2021

During the meeting, Faculty members of AMRF presented their work and received feedback from the external members - Prof. S. Karuthapandian, Professor & Head, Department of Biotechnology, Alagappa University, Karaikudi, Dr. S. Thiyagarajan, Faculty Scientist, Institute of Bioinformatics and Applied Biotechnology (IBAB), Bangalore, Prof. P. Venkatachalam, Professor of Human Genetics, Associate dean (Research), Department of Human Genetics, Sri Ramachandra Institute of Higher Education & Research, (DU), Porur, Chennai, Dr.G.Kumaresan, Associate Professor & Head, Dept of Genetics, Centre for xcellence in Genomic Sciences, School of Biological Sciences, Madurai Kamaraj University, Madurai

AWARDS

Zhongmei Chen Yong Award (Travel award) and Merit Abstract Award

Ms. Iswarya, Junior Research Fellow, Department of Stem Cell Biology received the ISSCR Zhongmei Chen Yong Travel Award and Merit Abstract Award for the research work titled Integration of cultured human trabecular meshwork (TM) stem cells to TM in a cell loss human anterior segment organ culture (HOCAS) model at the Annual Meeting of International Society of Stem Cell Research (ISSCR) (Virtual) held during June 21-26, 2021.

Best Poster and Oral presentation

Junior Research Fellows, Ms. Sumaiya Sirajudeen, Proteomics Department and Ms. Waseema Arif, Department of Stem Cell Biology won the Best Oral Presentation and Best Poster Award respectively at ARVO- IC –Indian Eye Research Group (IERG) Meeting (Virtual) held during October 7-10, 2021.

19th Research Advisory Committee Meeting



Ph.D awarded by Madurai Kamaraj University



K. Thirumalairaj
Department of Molecular Genetics
Thesis: Characterization of Genetic and Transcriptional Alterations in Retinoblastoma
Guide : Dr.A.Vanniarajan



T.S. Balaji
Department of Molecular Genetics
Thesis: Understanding the Molecular Mechanisms of Chemoresistance in Retinoblastoma
Guide: Dr.A. Vanniarajan



M. Durga
Department of Molecular Genetics
Thesis: Molecular Genetics of Macular Corneal Dystrophy (MCD) in Indian population
Guide: Dr.P. Sundaresan

Ph.D Defense (Virtual)

A.Aloysius Abraham, Department of Molecular Genetics defended his Ph.D thesis titled "*Identification of Modifier Genes Involved in Tumorigenesis of Retinoblastoma*" (Submitted to Alagappa University) on January 10, 2022.

Guide: Dr.A.Vanniarajan

K.Lavanya, Department of Stem cell Biology defended her Ph.D thesis titled "*Micro RNAs Specific to Corneal Epithelial Stem Cells*" (Submitted to Alagappa University) on January 25, 2022.

Guide: Dr.Gowri Priya Chidambaranathan

PUBLICATIONS 2021 - 2022

DURGA MURUGAN, SINDHURA DEVI ADSUMILLI, NAMPERUMALSAMY VENKATESH PRAJNA, PERIASAMY SUNDARESAN

- *"Molecular Genetics and Clinical Aspects of Macular Corneal Dystrophy" Advances in Vision Research - Vol.III :Genetic eye research around Globe (2021) pp 289-302*

DIVYA ARUNACHALAM, VENKATESH PRAJNA NAMPERUMALSAMY, LALITHA PRAJNA, DHARMALINGAM KUPPAMUTHU

- *"Human corneal epithelial cells internalize Aspergillus flavus spores by actin mediated endocytosis"*

Infection and Immunity 2021 May 17;89(6)

WONG SSW, VENUGOPALAN LP, BEAUSSART A, KARNAM A, SHAIT MOHAMMED MR, JAYAPAL JM, BRETAGNE S, BAYRY J, PRAJNA L, DHARMALINGAM K, LATGÉ J-P, AIMANIANDA V.

- *"Species-Specific Immunological Reactivities Depend on the Cell-Wall Organization of the Two Aspergillus, Aspergillus fumigatus and A. flavus".*

Front Cell Infect Microbiol. 2021;11:643312

RADHIKA THUNDIKANDY, GOWRI PRIYA CHIDAMBARANATHAN, NAVEEN RADHAKRISHNAN, RATHINAM SR

- *"In Vivo Confocal Microscopic Evaluation of the Limbus and Cornea in Vogt Koyanagi Haradas Syndrome"*

Ocular Immunology and Inflammation 2021 Apr 1;1-8

SUDHA PRIYA SOUNDARA PANDI, ANAND RAJENDRAN, SANTHI RADHA KRISHNAN, MINU JENIFER ANTO, TOM GARDINER, USHA CHAKRAVARTHY, MUTHUKKARUPPAN VEERAPPAN

- *"Characterization of age-related macular degeneration in Indian donor eyes"*

Indian J Ophthalmol 2021;69:642-6.

ATIKAH HANEEF, RAMPRASAD OBULA GIRIDHARA GOPALAN, DIVYA T. RAJENDRAN, JESSICA NUNES, DHARMALINGAM KUPPAMUTHU, NAVEEN RADHAKRISHNAN, TAI-HORNG YOUNG, HAO- YING HSIEH, NAMPERUMALSAMY VENKATESH PRAJNA, COLIN E.WILLOUGHBY, RACHEL WILLIAMS

- *"Chemical Cross-Linking of Corneal Tissue to Reduce Progression of Loss of Sight in Patients with Keratoconus"*

Transl Vis Sci Technol. 2021;10(5):6

SRIEE VISWARUBHINY, RUPA ANJANAMURTHY, AYYASAMY VANNIARAJAN, DEVARAJAN BHARANIDHARAN, VIJAYALAKSHMI PERUMALSAMY, AND PERIASAMY SUNDARESAN

- *"Clinical exome sequencing facilitates the understanding of genetic heterogeneity in Leber congenital amaurosis patients with variable phenotype in southern India"*

Eye and Vision (2021) 8:20

HAZARIKA M, PRAJNA NV, SENTHILKUMARI S.

- *"Drug reservoir function of voriconazole impregnated human amniotic membrane: An in vitro study"*

Indian J Ophthalmol 2021;69:1068-72

XIANJUN ZHU, MU YANG, PEIQUN ZHAO, SHUJIN LI, LIN ZHANG, LULIN HUANG, YI HUANG, PING FEI, YEMING YANG, SHANSHAN ZHANG, HUIJUAN XU, YE YUAN, XIANG ZHANG, XIONG ZHU, SHI MA, FANG HAO, PERIASAMY SUNDARESAN, WEIQUN ZHU, AND ZHENGLIN YANG

- *"Catenin α 1 mutations cause familial exudative vitreoretinopathy by overactivating Norrin/ β -catenin signalling"*

J Clin Invest. 2021;131(6):e139869

KUMAR JEYAPRAKASH, THENNARASU SHANTHINI, USHA KIM, VEERAPPAN MUTHUKKARUPPAN, AYYASAMY VANNIARAJAN

- *"Human papillomavirus in retinoblastoma: A tertiary eye care center study from South India"*

Indian J Ophthalmol 2021 Aug; 69(8): 2111–2115.

SEKARAN BALAJI, USHA KIM, VEERAPPAN MUTHUKKARUPPAN AND AYYASAMY VANNIARAJAN

- *"Emerging role of tumor microenvironment derived exosomes in therapeutic. Resistance and metastasis through epithelial-to-mesenchymal transition"*

Life Sciences 2021 Sep 1; 280:119750

YOGAPRIYA SUNDARESAN, DR. KRISHNADAS SUBBIAH RAMASAMY, MUTHUKKARUPPAN VEERAPPAN, GOWRI PRIYA CHIDAMBARANATHAN

- *"Functional characterization of adult human trabecular meshwork stem cells"*

Experimental Cell Research 405 (2021) 112709

CHEN CHEN, MU YANG, LULIN HUANG, RULIAN ZHAO, PERIASAMY SUNDARESAN, XIANJUN ZHU, SHUJIN LI, AND ZHENGLIN YANG

- *"Whole-Exome Sequencing Reveals Novel TSPAN12 Variants in Autosomal Dominant Familial Exudative Vitreoretinopathy"*

Genetic testing and Molecular biomarkers 2021 Jun;25(6): 399-404

RAJAPANDIAN SIVA GANESA KARTHIKEYAN, GUNASEKARAN RAMESHKUMAR, CHIDAMBARANATHAN GOWRI PRIYA, PRAJNA LALITHA, RAMAMOORTHY DEVI, MANI ISWARYA, RAVILLA D. RAVINDRAN

- *"Seroprevalence of SARS-CoV-2 specific IgG antibodies among eye care workers in South India"*

Indian Journal of Medical Microbiology Oct-Dec 2021; 39(4):467-472

MOHD HUSSAIN SHAH, MANOJKUMAR KUMARAN, PRAKASH CHERMAKANI, MOHIDEEN ABDUL KADER, R RAMAKRISHNAN, SUBBIAH R KRISHNADAS, BHARANIDHARAN DEVARAJAN, PERIASAMY SUNDARESAN

- *"Whole exome sequencing identifies multiple pathogenic variants in a large South Indian family with primary open angle glaucoma"*

Indian Journal of Ophthalmology 2021; 69(9), 2461–2468

KANDASAMY KATHIRVEL, O.RUDHRAA, SIVA GANESA KARTHIKEYAN RAJAPANDIAN, NAMPERUMALSAMY VENKATESH PRAJNA, PRAJNA LALITHA, BHARANIDHARAN DEVARAJAN

- *"Characterization of antibiotic resistance and virulence genes of ocular methicillin-resistant staphylococcus aureus strains through complete genome analysis"*

Exp Eye Res. 2021; 212 (11)

SWATHI CHADALAWADA, KANDASAMY KATHIRVEL, PRAJNA LALITHA, S.R. RATHINAM, Bharanidharan Devarajan

- *"Dysregulated expression of microRNAs in aqueous humor from intraocular tuberculosis patients"*

Mol Biol. Rep 2022; 49: 97-107

SUSMITA CHOWDHURY, ROOPAM DUVESH, MANOJKUMAR KUMARAN, RUPA ANJANAMURTHY, JAYANT KUMAR, AYYASAMY VANNIARAJAN, BHARANIDHARAN DEVARAJAN, PERIASAMY SUNDARESAN

- *"Clinical reassessments and whole-exome sequencing uncover novel BEST1 mutation associated with bestrophinopathy phenotype"*

Ophthalmic Genet.2022; 43 (2)

MANOJKUMAR KUMARAN, BHARANIDHARAN DEVARAJAN

- *"Bioinformatics for whole exome Studies" Forero DA, editor. Bioinformatics and Human Genomics Research.*

New York CRC Press, Taylor & Francis Group 2021

RAJENDRABABU S, PALLAMPARTHY S, ARUNACHALAM A, UDUMAN MS, SRINIVASAN S, Krishnadas SR, SENTHILKUMAR VA.

- *"Incidence and risk factors for postoperative intraocular pressure response to topical prednisolone eye drops in patients undergoing phacoemulsification".*

Int Ophthalmol.2021 Dec; 41(12):3999-4007

MEGHANA TANWAR, SEKARAN BALAJI, AYYASAMY VANNIARAJAN, USHA KIM, GUNJA CHOWDHURY

- *"Parental age and retinoblastoma – a retrospective study of demographic data and genetic analysis"*

Eye 2022; 36: 57-63

YOGAPRIYA SUNDARESAN, LAKSHMI PRIYA MANIVANNAN, SHANTHI RADHAKRISHNAN, KRISHNADAS SUBBIAH RAMASAMY, MUTHUKKARUPPAN VEERAPPAN, GOWRI PRIYA CHIDAMBARANATHAN

- *"Reduction in trabecular meshwork stem cell content in donor eyes with primary open angle glaucoma"*

Scientific Reports (2021) 11:24518

DIVYA ARUNACHALAM, SHRUTHI MAHALAKSHMI RAMANATHAN, ATHUL MENON, LEKSHMI MADHAV, GOPALAKRISHNA RAMASWAMY, VENKATESH PRAJNA NAMPERUMALSAMY, LALITHA PRAJNA, DHARMALINGAM KUPPAMUTHU

- *"Expression of immune response genes in human corneal epithelial cells interacting with Aspergillus flavus conidia"*

BMC Genomics 2022; 23:5

CHITARANJAN MISHRA, ROOPAM DUVESH, SUSMITA CHOWDHURY, RUPA ANJANAMURTHY, Naresh BABU KANNAN, KIM RAMASAMY, PERIASAMY SUNDARESAN

- *"Analysis of microstructural changes in an X-linked juvenile retinoschisis patient harboring RS1 G668A mutation by en-face optical coherence tomography imaging"*

Indian J Ophthalmol Case Rep 2022; 2:136-9

MOHAN M, SHETTY S, PERUMALSAMY V, PRAKASH C, SUNDARESAN P.

- *"Clinical and genetic aspects of a child with monilethrix and visual rehabilitation"*

Indian J Ophthalmol Case Rep 2022;2:211-3.

ONGOING RESEARCH PROJECTS

No	Projects	Funded by	Investigators	Research Scholar
PROTEOMICS				
1.	Study on Human mycotic keratitis	AMRF & AEH	Dr.N. Venkatesh Prajna Dr.Lalitha Prajna Dr. J. Jeya Maheshwari Dr. K.Dharmalingam Dr.O.G.Ramprasad	A. Arun Alexander
2.	Prospective Multicenter discovery and validation of diagnostic circulating and urinary biomarkers and development of sensor(s) to detect sight threatening diabetic retinopathy - Biomarker and Biosensor study in UK and India (Indo-UK collaborative project)	Research Councils UK 2018 to Mar.2022	Dr. K. Dharmalingam Dr. R.Kim Dr. J. Jeya Maheshwari	Subash KK
3.	Proteome profiling of serum microparticles in diabetes and diabetic retinopathy patients: Towards identification and validation of predictive biomarkers	Department of Health Research (DHR) 2019- Jan.2022	Dr.J. Jeya Maheshwari Dr.K.Dharmalingam Dr.R.Kim	Subash KK
4.	Prediction of treatment outcome in fungal keratitis patients	Cognizant Foundation 2019- Dec.2021	Dr. K.Dharmalingam Dr. J. Jeya Maheshwari Dr. Bharanidharan D Dr. N. Venkatesh Prajna Dr. Lalitha Prajna	T.S.Pon Yazhini
5.	Development of aptamer-based assays for diagnosis of infectious keratitis and absolute quantitation of proteoform markers of diabetic retinopathy	Sun Pharma Sep 2019 – Aug.2022	Dr. J. Jeya Maheshwari Prof. K. Dharmalingam Dr. N. Venkatesh Prajna Dr. R. Kim	Susan Immanuel
6.	Screening the Kadaladi family with early onset Glaucoma for Myocilin gene mutations	Sun Pharma Sep 2019 – Aug.2022	Prof. K. Dharmalingam Dr. S.R. Krishnadas Dr. Mohideen Abdul Khadar Dr. D. Bharanidharan	Sr.Technician V. Saravanan
7.	Understanding the role of extracellular vesicles in the modulation of host immune response in fungal keratitis	Sun Pharma Mar.2021 – Aug.2022	Dr. J. Jeya Maheshwari Dr. K.Dharmalingam Dr. N. Venkatesh Prajna Dr. Lalitha Prajna	Subash KK Hariharan G
8.	Understanding the mechanism of action of a novel chemical cross-linker designed to treat keratoconus	ICMR 2020 – May 2023	Dr.O.G.Ramprasad Prof. K. Dharmalingam Dr. N.Venkatesh Prajna Dr. Naveen Radhakrishnan	Sumaiya Sirajudeen G. Adhithya Subramanian
9.	Identification of druggable targets for attenuating the progression of pterygium development	Sun Pharma Sep 2019 – Aug 2022	Dr. Daipayan Banerjee Dr. Vishnu Teja Dr.N. Venkatesh Prajna Dr. K.Dharmalingam	Aadithiya T Gr

10.	Role of Retinol Binding Protein 3 (RBP3) in progression of Diabetic Retinopathy (DR) and evaluate its potential as a DR biomarker in Type 2 diabetic patients.	VISTA Jan 2021 – Dec.2021	Dr. Daipayan Banerjee Dr. Sagnik Sen Dr.R.Kim Dr. K.Dharmalingam	Aadithiya T Gr
11.	Ectosomes and exosomes in ocular diseases: Towards the development of novel diagnosis and reconfigurable therapeutics (Role of Extracellular Vesicles in pathogenesis of Diabetic Retinopathy)	Sun Pharma Mar.2021 – Aug.2022	Dr. Daipayan Banerjee Dr. Sagnik Sen Dr. Naresh Babu Dr.R.Kim Dr. K.Dharmalingam	Aadithiya T Gr
MICROBIOLOGY				
12.	Development and validation of a non-invasive point-of-care diagnostic tool for fungal keratitis	VELUX STIFTUNG 01.08.2021 – 31.07.2025	Dr.N.Venkatesh Prajna Dr. Lalitha Prajna Dr.K. Dharmalingam Dr.Thulasiraj Ravilla Dr.N. Siddharth	Hanithraj D. Padmapriya S Humera Khathun Vignesh P
13.	Identification of Dysregulated MicroRNAs In Ocular Fluids as Diagnostic Markers for Intraocular Tuberculosis	ICMR-SRF Jul.2019 – June 2022	Dr.D.Bharanidharan	Swathi Chadalawada
14.	Role of Human Corneal MiRNAs in the onset and severity of Fungal Keratitis	ICMR Nov.2021 Nov.2023	Dr. D. Bharanidharan Dr. K. Dharmalingam Dr. N. Venkatesh Prajna Dr. Lalitha Prajna	Shreya Dinesh
MOLECULAR GENETICS				
15.	Molecular Characterization of Leber's Congenital Amaurosis in South Indian Cohort	Lady Tata Memorial Trust 02.01.2021 – 01.01.2026	Dr. P. Sundaresan	A.S. Sreee Viswarubhiny
16.	Investigating the Crosstalk between Nuclear and Mitochondrial Genome in Patients with Leber's Hereditary Optic Neuropathy	ICMR-SRF 01.03.2021 – 28.02.2024	Dr. P. Sundaresan	C. Prakash
17.	Molecular Genetics of Juvenile X-linked Retinoschisis in South Indian Population	Lady Tata Memorial Trust 01.08.2019 – 31.07.2023	Dr.P.Sundaresan	Susmita Chowdhury
18.	Identification and validation of deregulated cancer pathways in retinoblastoma	SERB 2018 – Jan.2022	Dr. A. Vanniarajan Dr. Usha Kim Dr. D. Bharanidharan Dr. R. Shanthi	T.S. Balaji
19.	Molecular characterization of tumor progression in retinoblastoma	DST INSPIRE Fellowship 09.06.2017 – 08.06.2022	Dr. A.Vanniarajan	T.Shanthini

20.	Translational Genomics of Ocular Cancers	Aravind Eye Foundation	Dr. Usha Kim Dr. A. Vanniarajan Dr. D. Bharanidharan Dr. R. Shanthi Dr. VR. Muthukkaruppan	K. Jeyaprakash
21.	Molecular characterization of ocular lymphoma for improved disease prognosis	Lady Tata Memorial Trust 01.08.2020 – 31.07.2025	Dr.A. Vanniarajan	K. Saraswathi
22.	Evaluation of GD2 synthase as a prognostic biomarker in retinoblastoma	VISTA Jan.2021 – Dec.2021	Dr. A. Vanniarajan	R. Sethu Nagarajan
IMMUNOLOGY AND STEM CELL BIOLOGY				
23.	Characterization of adult human lens epithelial stem cells in the maintenance of tissue homeostasis throughout life and their functional status in cataractous lens	SERB 29.05.2019 – 30.11.2022 Lady Tata Memorial Trust - SRF 01.08.2019 – 31.07.2023	Dr. Madhu Shekhar Dr. Gowri Priya Chidambaranathan Dr.Haripriya Aravind Prof. VR. Muthukkaruppan	M. Lakshmi Priya P. Saranya
24.	Identification and Characterization of adult human retinal pigment epithelial stem cells	CSIR-SRF 17.09.2018 – 16.09.2023	Dr. Gowri Priya Chidambaranathan	A.Waseema
25.	Adult stem cell derived extracellular vesicular miRNAs for trabecular meshwork regeneration in glaucoma	Sun Pharma UGC-JRF 03.06.2020 – 02.06.2025	Dr. Gowri Priya Chidambaranathan Dr. SR. Krishnadas Prof. VR. Muthukkaruppan	R. Iswarya
26.	Molecular regulators associated with the maintenance of human trabecular meshwork stem cells in relation to their reduction in ageing and glaucoma	SERB Oct.2021 – Oct.2024	Dr. Gowri Priya Chidambaranathan Dr. D. Bharanidharan Dr. S. R. Krishnadas Prof. VR. Muthukkaruppan	R. Nerethika
27.	miRNAs to reprogram human differentiated corneal epithelial cells towards lineage specific adult stem cells	Sun Pharma Jan.2021 – Mar.2022	Gowri Priya Chidambaranathan Dr. SR. Krishnadas Prof. VR. Muthukkaruppan	A.Waseema
28.	A preliminary study to generate tear producing lacrimal gland organoids from human cadaveric and biopsy samples	Sun Pharma Nov.2021 – Apr.2022	Dr. Anwar Azad P. Dr.Usha Kim Prof. K. Dharmalingam	Gowthami Shankar

OCULAR PHARMACOLOGY

29.	Role of miRNA in the regulation of Glucocorticoid Receptor (GR) signalling and Development of New therapeutics for Steroid-induced glaucoma	Wellcome-DBT /India Alliance Intermediate Fellowship (2017-30.09.2022)	Dr. S. Senthilkumari Dr. C. Gowri Priya Dr. D. Bharanidharan Dr. R. Sharmila	R. Hari balaganesh D.Yogamaya
-----	---	---	---	----------------------------------

BIOINFORMATICS

30.	Expression profiling of human corneal miRNAs and their role in Pseudomonas aeruginosa induced keratitis	DBT-BET	Dr. D. Bharanidharan	R.Praveenkumar
-----	---	---------	----------------------	----------------



Much has been done, but much remains to be done... we look to the future with renewed strength to continue the mission of providing quality eye care and hope that some of what we have learned will be useful to other eye care workers around the world.

G. Venkataswamy

ARAVIND MEDICAL RESEARCH FOUNDATION
DR. G. VENKATASWAMY EYE RESEARCH INSTITUTE

1, Anna Nagar, Madurai 625 020, Tamilnadu, India.
Phone: (0452) 435 6550

www.amrf.org.in

 **ARAVIND EYE CARE SYSTEM**